

National free service hotline
00862981504031

Stand on the ground, FUJISJ elevator

Smooth

Quiet

Safe

FUJI Elevator

- ◎ Add: F18, xinyuan center, No. 287, fenghe road, lianhu district, xi'an city, Shaanxi province, China
- ◎ Tel: 00862981504031
- ◎ WhatsApp: 86-13572276834
- ◎ Email: sales.support@elevator-fuji.com
- ◎ Http: //www.elevator-fuji.com

The printed products are for reference only. the company has the right change the designs and specifications of the products at any time. the information contained in the printed products dose not constitute any express or implied guarantees or commitmente for the products and its applicability, merchantability, and quality of special purposes, or any time of procurement agreement.

Printing in August 2021

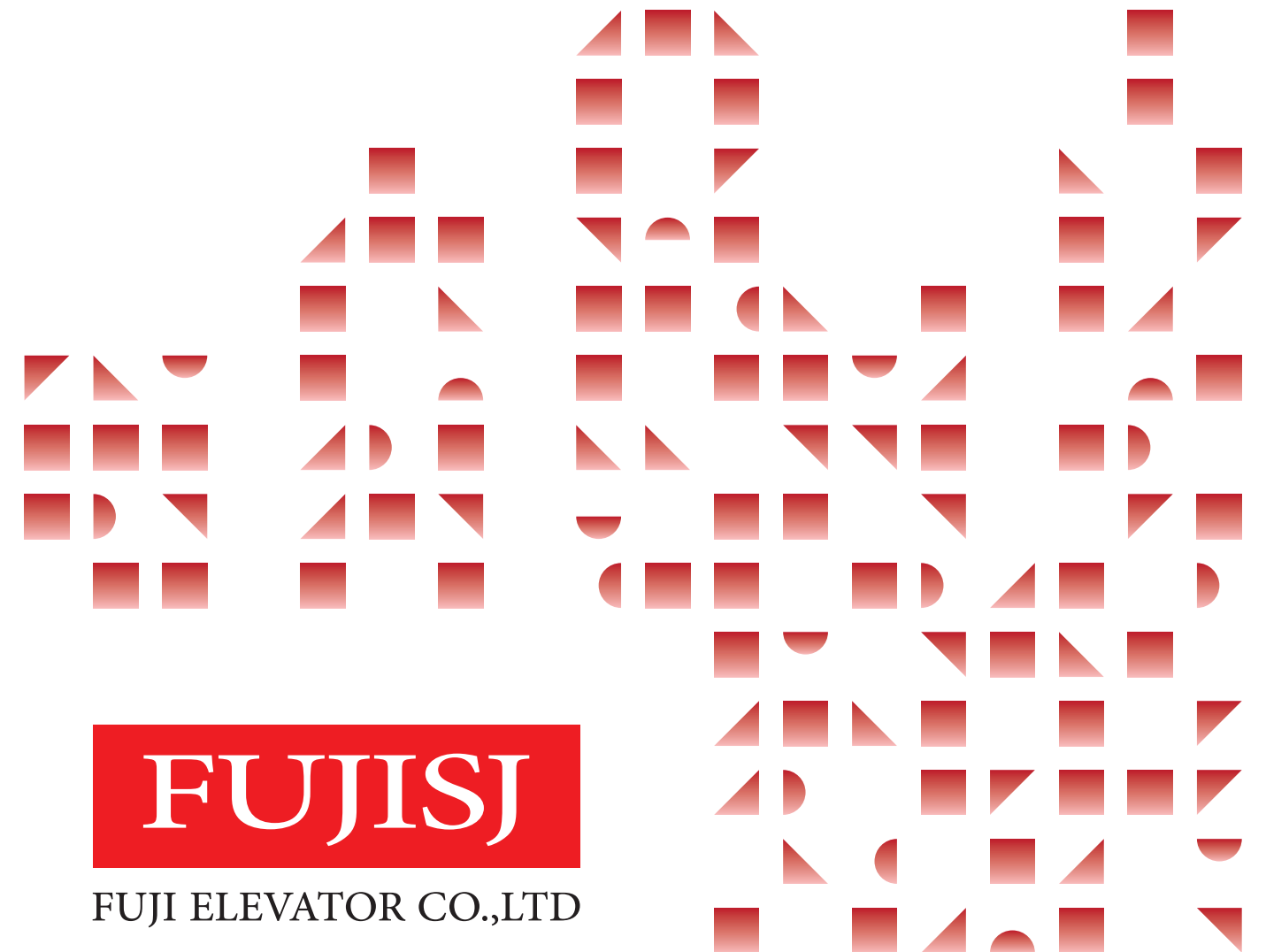

Company profile

Fuji Elevator has over 40-years History of elevator manufacturing , And It is the only national R&D and manufacturing base of Japan Fuji mechanical and electrical in China.





FUJISJ - the sponsor of feltless elevator



The world's first elevator company that integrates [program design, perception technology + AI intelligence] into the elevator field, and combines mechanical structure design to achieve a stable, comfortable and safe—feltless elevator.

About programming

FUJISJ feltless elevator is the world first to change the program design from traditional input type to adaptive data dictionary. The "big and small steps" in the previous speed control curve are finely ground into an extremely smooth "ice surface" that has no feeling of acceleration and deceleration.

The fusion of the perception technology and AI intelligence

FUJISJ feltless elevator adopts the fusion application of advanced real-time accurate load sensing technology and AI intelligent algorithm to realize the stepless weighing torque compensation and automatic adjustment of starting parameters, and truly made it start

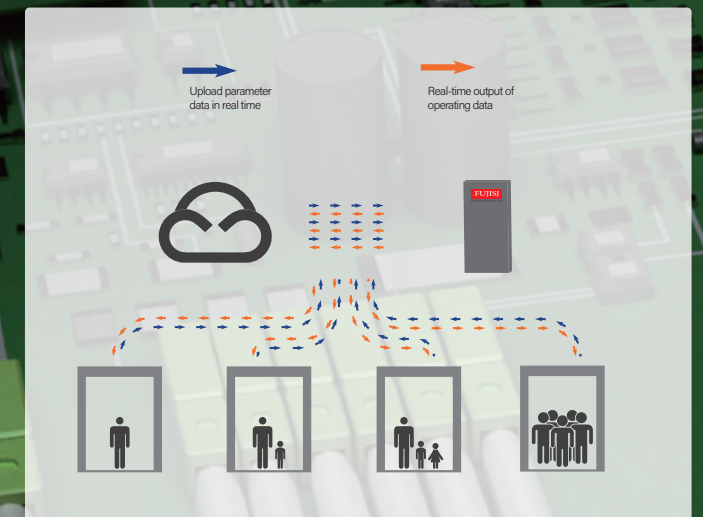

Mechanical structure design

FUJISJ feltless elevator has undergone tens of thousands of combined gravity compression + buffering experimental parameter tests, and obtained the optimal elastic coefficient fusion damping scheme required by each damping unit under different ladder structures, different speeds and load conditions, and perfectly The three are tested and matched, which comprehensively solves all the discomfort caused by the mechanical vibration of the elevator, making the running without feeling.

1.Six-year warranty on three major parts

① Six-year warranty scope:

Traction machine, Integrated control cabinet, Door operator.

② Warranty conditions:

The parts within the above range are guaranteed for six years under normal use environment and conditions. For damage caused by force majeure or improper use, management, and maintenance, the parts will be charged at the cost price.

2.Five years free replacement for consuming parts

Global brand FUJI Elevator, surpassing the industry rules, provides free elevator consuming parts for five years.



"stand on the ground, FUJISJ elevator - quiet, smooth, safe"
Fuji elevator Co., Ltd

FUJI ELEVATOR CO., LTD

富吉电梯有限公司



富吉电梯【2021】第3号

为进一步彰显富吉电梯与日本富士机电在电梯生产领域的强大技术实力,为用户提供高品质的产品与服务,实现电梯全生命周期价值最大化,富吉电梯重磅推出超长质保政策,具体内容如下:

电梯核心三大件免费质保6年

1. 曳引机(不包括曳引轮)
2. 控制柜(一体机)
3. 门机(门电机和门控器)

In order to further demonstrate the strong technical strength of Fuji Elevator and Fuji Electric in the field of elevator production and R&D, provide users with high-quality products and services, maximize the value of the elevator life cycle, Fuji Elevator has launched sales policy to benefit customer. The specific contents include:

Six-year free warranty for the three major parts of the elevator

1. Traction machine(except for pulley)
2. Control cabinet(integrate machine)
3. Door operator(door inverter and motor)



FUJI Elevator Co., Ltd
28th Sep 2021

Subject terms: Fuji elevator, free warranty
Issued: Fuji Elevator sales staff and agents worldwide
28th Sep 2021 print **Total 1 copy**



"stand on the ground, FUJISJ elevator - quiet, smooth, safe"
Fuji elevator Co., Ltd

FUJISJ Elevator Consuming parts list

FUJISJ 电梯易损备品备件清单

Items 序号	Consuming parts 易损件备品	Used for specific parts 所用设备	Manufacturer 制造厂	Quantity 数量
1	Landing door Slider 层门滑块	Landing door sill 层门地坎	FUJISJ	20
2	Car oil cup 轿厢油杯	Car top 轿厢顶	FUJISJ	4
3	Counter weight oil cup 对重油杯	Sub guide rail 副导轨	FUJISJ	4
4	Oil box 接油盒	Pit 底坑	FUJISJ	8
5	Limit switch (NC)限位开关(常闭)	Shaft 井道	FUJISJ	2
6	Door lock contact 门锁触点	Landing door 厅门	FUJISJ	5
7	Female Lock contact 付锁触点	Landing door 厅门	FUJISJ	5
8	Car guide shoe 轿厢导轨靴衬	Guide rail 导轨	FUJISJ	5
9	Counter weight guide shoe 对重靴衬	Guide rail 导轨	FUJISJ	5
10	Lighting switch 照明开关	Switch 开关	FUJISJ	5
11	Triangle lock 三角锁	Guide rail 厅门	FUJISJ	5
12	Multi-functional keys 多功能钥匙	Guide rail 厅门	FUJISJ	5
13	Fuse 控制柜保险丝	Controller 控制柜	FUJISJ	5
14	Anti-collision rubber pad 防撞	Landing door 厅门	FUJISJ	5
合计 Total	83pcs / 83 件			

注: 最终解释权归本公司所有

Note: The final interpretation right belongs to the company.

Tel: +86-29-81504031 Web: <https://www.elevator-fuji.com>
Head Office Address: F18, Xinyuan Centre, No.287, Fenghe road, lianhu district, xi'an city, Shaanxi Province, china



High speed elevator

Adopt super high speed elevator serial control system

The control system adopts a 32-bit networked intelligent serial communication elevator special control system, which greatly improves the CPU operation speed. The four-layer sheet paste technology, CAN bus serial communication, thus ensuring a large amount of data high-speed reliable transmission.

It applies new style shock-absorbing device.

It sets shock-absorbing device to isolate shock between elevator car and car frame. It nicely buffers vibration in the elevator running process. It reduces the elevator car vibration and enhances the passengers' comfortable travel.

Combined car wall connection ensures static car effects, fine sealing and stability of air pressure.



Small machine room passenger elevator

The small machine room passenger elevator adopts an energy-efficient, low-speed, permanent-magnet synchronous gearless traction machine. Compared with a geared elevator with equivalent load level, it saves about 33% of energy. The specially designed small-size control cabinet combines the most advanced low-loss IGBTs and the best design solutions to make the room space perfectly arranged.

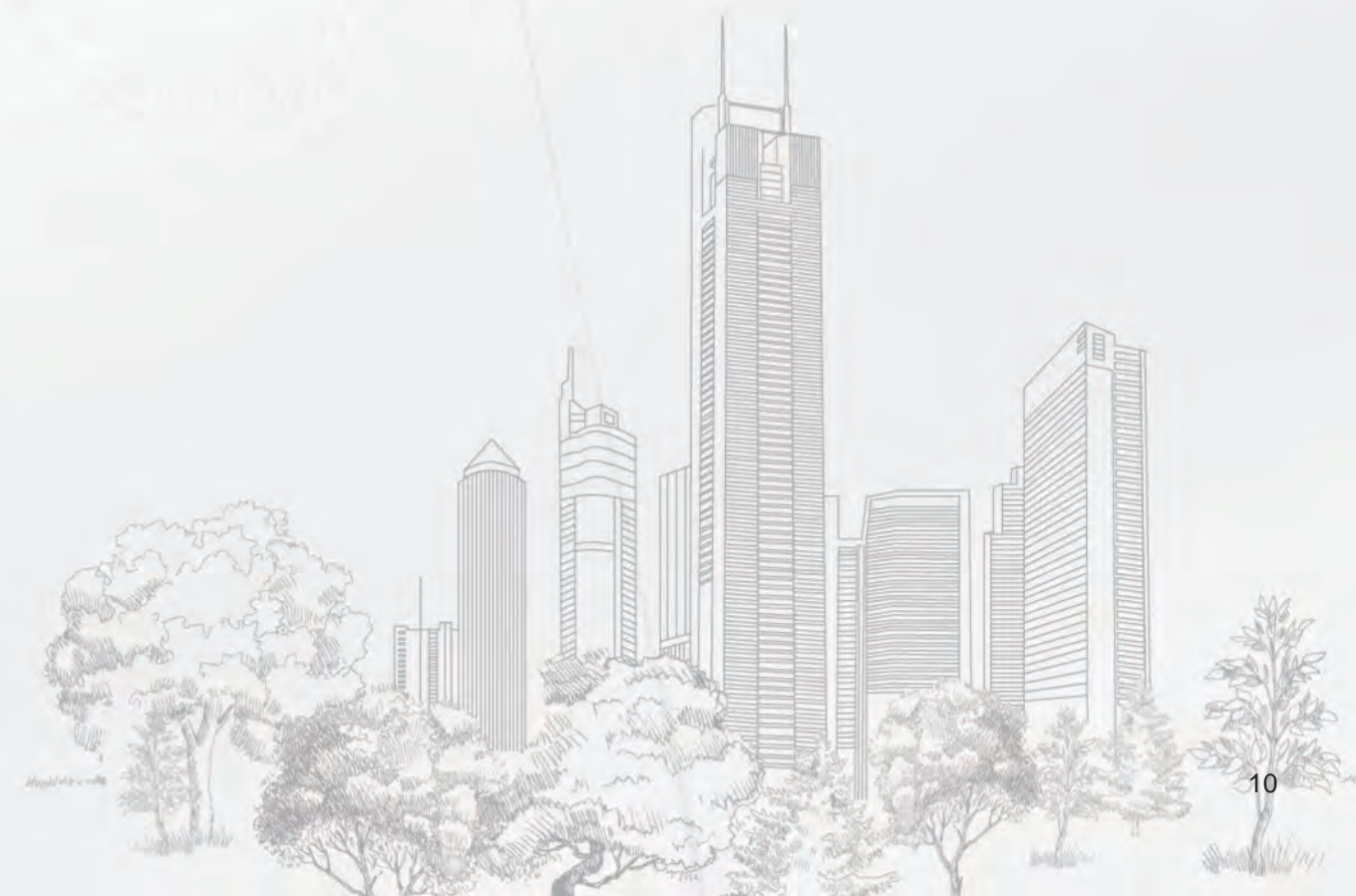

Machine roomless passenger elevator

The elevator without machine room passengers is well aware of the concept of environmental protection, saving energy and reducing consumption, saving floor space and improving design freedom. Compared with geared elevators of the same load class, energy savings are more than 33%. FUJI machine-room passenger lift broke through the premise that the elevator must set up a machine room, providing perfect creation for the limited space of modern architecture.

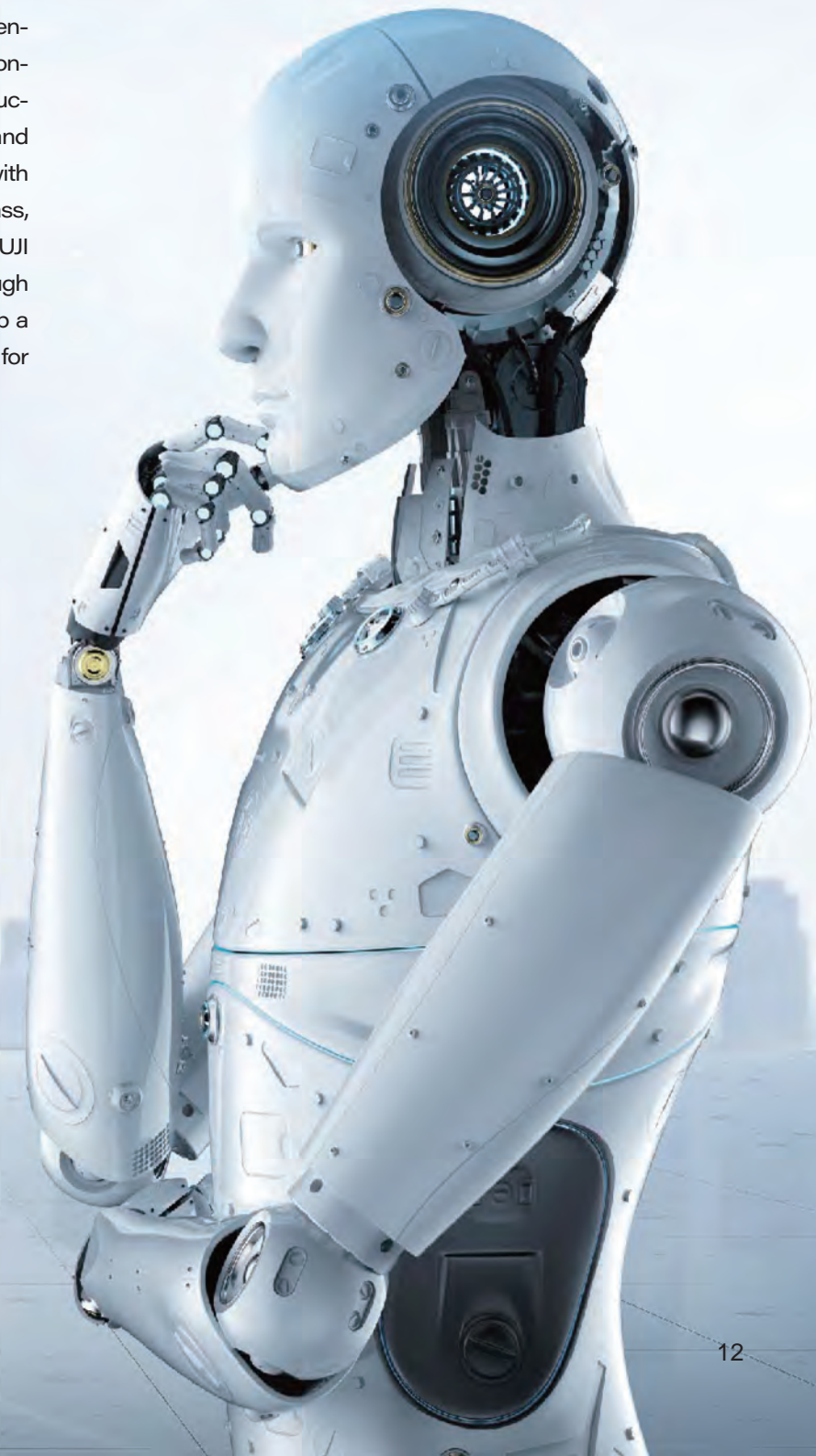

Car decoration

JG-K01 ▶

Ceiling : Central image arch, stainless steel bottom panel is supplemented with soft lighting design of down lamp on both sides
 Car wall : Mirror, etched, hairline
 Handrail : Stainless steel tube handrail
 Floor : PVC



JG-K03 ◀

Ceiling : Stainless steel mirror hollow plate and white organic board, Aluminum alloy frame
 Car wall : Titanium, mirror, etched, hairline, vibration
 Handrail : Titanium stainless steel triple combination
 Floor : PVC

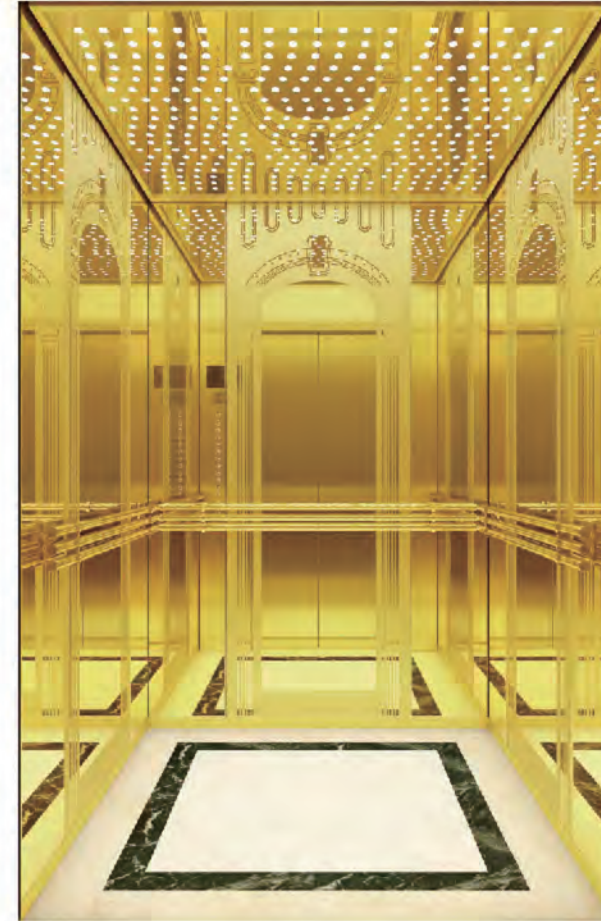

JG-K02 ◀

Ceiling : Central image arch, stainless steel bottom panel is supplemented with soft lighting design of down lamp on both sides
 Car wall : Mirror, etched, hairline
 Handrail : None
 Floor : PVC



JG-K04 ▶

Ceiling : Stainless steel mirror base plate, golden down lamp and car wall enhance each other's beauty. Central part is soft lighting design of arch white organic light-emitting board.
 Car wall : Mirror, etched, hairline
 Handrail : Stainless steel flat handrail
 Floor : PVC



Car decoration

JG-K05 ▶

Ceiling : Etched titanium gold mirror, central ceiling lamp, LED at four sides
 Car wall : Marble or imitation marble grain, etched titanium-plated stainless steel mirror, titanium gold mirror stainless steel
 Handrail : None
 Floor : PVC



JG-K08 ◀

Ceiling : Veneer or imitation veneer frame, white organic panel, mirror frame
 Car wall : Veneer or imitation veneer surface, central make-up mirror
 Handrail : Combination of round wood and titanium gold
 Floor : PVC



JG-K07 ◀

Ceiling : Central white light-emitting panel, veneer or imitation veneer model craft panel and auxiliary lighting of down lamp at four sides
 Car wall : Veneer or imitation veneer decoration panel combines with titanium gold stainless steel
 Handrail : Wood handrail
 Floor : PVC



JG-K09 ▶

Ceiling : Hairline stainless steel frame, acrylic light-emitting panel
 Car wall : Hairline, mirror, etched
 Handrail : Stainless steel flat handrail
 Floor : PVC



Car decoration

JG-K10 ▶

Ceiling : Stainless steel side frame, organic strip decoration, ventilation hole, central acrylic arch
 Car wall: PVD coated etched stainless steel
 Handrail: None
 Floor : PVC

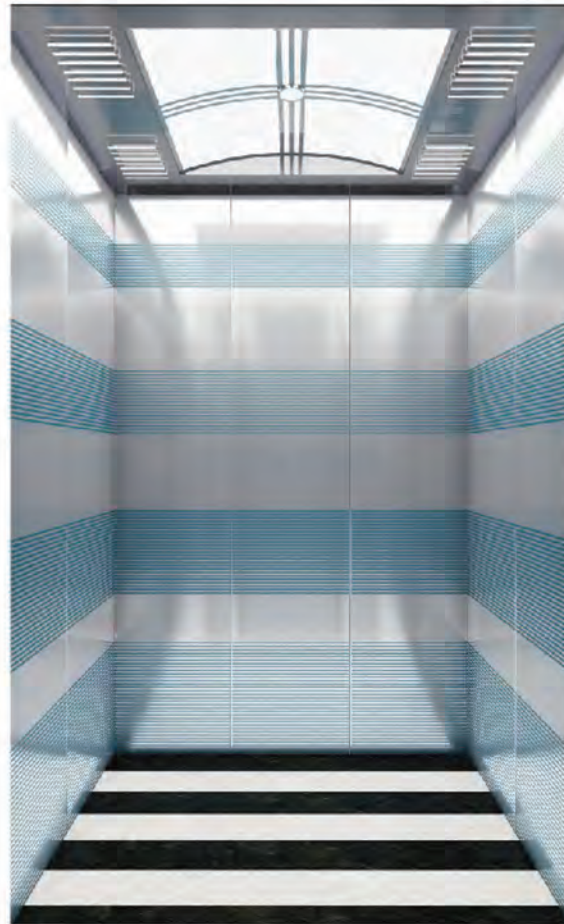

JG-K11 ◀

Ceiling : Bronze mirror frame matches with acrylic lighting decoration
 Car wall : Irregular grain stainless steel is inlaid with stainless steel mirror strip
 Handrail : None
 Floor : Marble parquet or imitation marble PVC



JG-K14 ◀

Ceiling : Hairline stainless steel frame, acrylic light-emitting panel, down lamp
 Car wall : Marble or imitation marble grain, mirror etching stainless steel
 Handrail : None
 Floor : PVC

JG-K17 ▶

Ceiling : Mirror stainless steel frame, acrylic light-emitting panel
 Car wall : Printed safety glass, mirror stainless steel
 Handrail : Stainless steel flat handrail
 Floor : PVC



JG-K18 ◀

Ceiling : Black titanium mirror stainless steel frame, acrylic lighting decoration
 Car wall : Black titanium mirror etched stainless steel on both sides, soft package on back wall center plate, auxiliary plate black titanium mirror stainless steel
 Handrail : None
 Floor : PVC



Observation elevator

Up/down flowing scene

With a transparent car design, it is possible to realize the beautiful sight of the sightseeing area and enjoy the beautiful scenery in the urban architectural complex. Applicable to hotels, shopping malls, public buildings and other places.

Observation elevator car decoration



JG-G01 ◀

- Car cover : Back enamel steel, hairline stainless steel, lighting decoration
- Observation wall : 6+6 laminated safety glass (3PCS)
- Decoration ceiling : Hairline stainless steel, acrylic lighting decoration, down lamp
- Car wall : Hairline stainless steel
- Handrail : Stainless steel tube handrail
- Floor : PVC



JG-G02 ◀

- Car cover : Steel plate baked enamel pressed reinforced bar, acrylic strip lighting decoration
- Observation wall : Round 6+6 laminated safety glass (3PCS)
- Decoration ceiling : Baked enamel steel frame, acrylic lighting decoration
- Car wall : Hairline stainless steel
- Handrail : Stainless steel tube handrail
- Floor : PVC



JG-G03 ◀

- Car cover : Baked enamel steel plate, lamp strip decoration
- Observation wall : Round 6+6 laminated safety glass (3PCS)
- Decoration ceiling : Baked enamel steel frame, acrylic lighting decoration
- Car wall : Hairline stainless steel
- Handrail : Stainless steel double tube
- Floor : PVC

Observation elevator car decoration



JG-G04 ◀

- Car cover : Round chamfer baked enamel steel plate, slant face with down lamp
- Observation wall : Round 6+6 laminated safety glass (3PCS)
- Decoration ceiling : Baked enamel steel frame, acrylic light-emitting panel and down lamp
- Car wall : Hairline stainless steel
- Handrail : Stainless steel tube
- Floor : PVC



JG-G05 ◀

- Car cover : Steel plate baked enamel pressed reinforced bar, acrylic lighting decoration
- Observation wall : Round 6+6 laminated safety glass (3PCS)
- Decoration ceiling : Baked enamel steel, cylindrical acrylic crystal lamp
- Car wall : Hairline stainless steel
- Handrail : Stainless steel double tube
- Floor : PVC



JG-G06 ◀

- Car cover : Creamy white acrylic hood, 3D steel plate model, down lamp
- Observation wall : 6+6 laminated safety glass (3PCS)
- Decoration ceiling : Baked enamel steel top panel, Central round acrylic lighting decoration, acrylic crystal lamp decoration
- Car wall : Hairline stainless steel
- Handrail : Stainless steel tube
- Floor : PVC

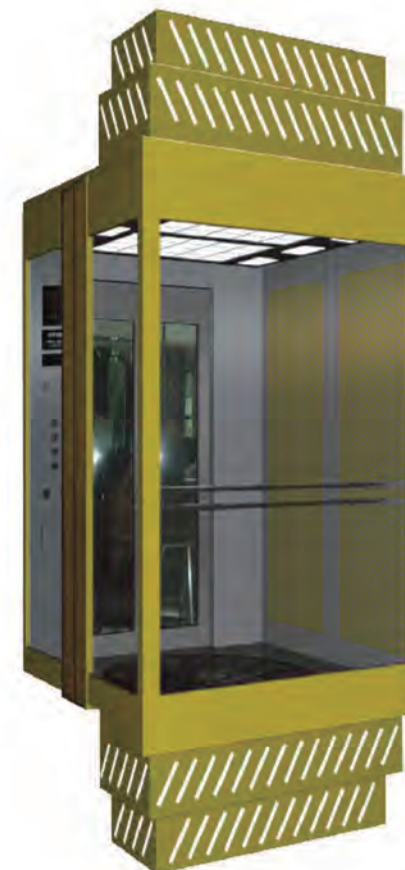

JG-G08 ◀

- Car cover : Baked enamel steel, lighting decoration
- Observation wall : 6+6 laminated safety glass (3PCS)
- Decoration ceiling : Baked enamel steel, acrylic lighting decoration
- Car wall : Hairline stainless steel
- Handrail : Stainless steel double tube
- Floor : PVC

Hospital elevator

A beautiful human-oriented world

FUJI hospital elevator series, taking full account of the uniqueness of the hospital environment, using the world's cutting-edge modular computer control technology, formed a highly integrated VVVF serial communication control system, So that the elevator brake smooth, smooth operation, patient times Feel comfortable. The design of multiple safety features effectively reduces the probability of accidents and allows safe and inaccessible patients access.



Hospital elevator car decoration

JG-B01 ▶

- Ceiling : Hairline stainless steel LED energy saving light
- Ventilation : Axial fan
- Car wall: Hairline stainless steel
- Handrail: Double flat stainless steel
- Floor : PVC floorboard



Negative ion car technology

Leading the use of natural oxygen bar car technology, air negative ions are like vitamins in food, increasing negative oxygen ions to improve the air quality of car, more conducive to patients riding the ladder.

JG-B02 ▶

- Ceiling : Painted steel plate, LED energy saving light
- Ventilation : Axial fan
- Car wall: Hairline stainless steel
- Handrail: Stainless steel tube
- Floor : PVC floorboard



Ultraviolet sterilizer

Considering the complexity of the people used in the hospital bed elevator, ultraviolet sterilization device is installed in the car, and ultraviolet disinfection is carried out when the elevator starts. Dust removal and decontamination, disinfection and sterilization, smoke elimination and deodorization, etc.



Villa elevator

Perfect & comfortable life

Designed to match the distinguished experience of a stylish home in a luxury private home, it is designed primarily for home users. Its sophisticated layout, variety of styles, and outstanding performance make it an indispensable luxury furniture for your villa home.



Villa elevator car decoration

FSJG-V003 ▶

- Ceiling: Titanium gold stainless steel frame, Central acrylic decoration, LED down lamp
- Car wall: Titanium gold, mirror, Etched stainless steel
- Handrail: None
- Floor: Marble



FSJG-V006 ◀

- Ceiling: Wooden decoration inlaid with titanium gold mirror decoration strip, four-side hidden soft light source, central high grade decoration strip
- Car wall: Wooden model frame inlaid with wooden decoration, etched stainless steel
- Handrail: None
- Floor: Teakwood floor



FSJG-V004 ◀

- Ceiling: Titanium gold mirror stainless steel frame, acrylic light decoration, LED down lamp
- Car wall: Titanium gold stainless steel, Titanium gold mirror stainless steel (Rear wall central panel)
- Handrail: None
- Floor: Marble

FSJG-V007 ▶

- Ceiling: Titanium gold mirror stainless steel, acrylic transparent board
- Car wall: Titanium gold mirror stainless steel, Titanium gold vibration plate
- Handrail: Golden stainless steel round tube handrail
- Floor: Marble parquet (optional PVC)



Villa elevator car decoration

FSJG-V008 ▶

- Ceiling: Titanium gold mirror frame, acrylic lighting decoration, down lamp
- Car wall: Titanium gold and corrugated mirror stainless steel, Titanium gold mirror stainless steel
- Handrail: Titanium gold mono-tube round handrail
- Floor: Marble parquet (optional PVC)



JG-K15 ◀

- Ceiling: Mirror stainless steel frame, acrylic lighting decoration
- Car wall: Veneer or imitation veneer decoration panel, mirror stainless steel
- Handrail: Wood handrail
- Floor: PVC



JG-K13 ◀

- Ceiling: Painted steel plate, central titanium gold stainless steel mirror, down lamp
- Car wall: Veneer or imitation veneer decoration panel, Titanium gold etching stainless steel
- Handrail: Combined handrail of titanium gold and solid wood
- Floor: PVC



JG-K19 ▶

- Ceiling: Stainless steel frame, Acrylic lighting decoration, Down lamp
- Car wall: Hairline stainless steel, Mirror stainless steel
- Handrail: None
- Floor: PVC





Freight elevator

FUJI cargo elevators are easy to carry and adapt under all kinds of operating conditions, making more weightlifting and more than adequate. Create a new concept of cargo delivery.

Machine roomless freight elevator

FUJI machine-room-less elevator products are designed with low-carbon and environmental protection, saving energy and reducing consumption, fully embodying the product's green humanistic spirit. Compared with geared elevators of the equivalent load class, electric energy is saved by about 40%, saving 10% of the building area.

Freight elevator car decoration

JG-J60 ▼

Ceiling: Paint steel
Car wall/Car door: Paint steel
Illumination: Energy-saving light
Door opening mode: Side opening
Floor: Checkered plate



JG-J61 ▼

Ceiling: Hairline stainless steel
Car wall/Car door: Hairline stainless steel
Illumination: Energy-saving light
Door opening mode: Center-opening & doublefolded type
Floor: Checkered plate





Escalator

FUJI escalators are manufactured using international advanced technology and advanced design concepts to provide passengers with a new feeling of brightness and comfort, allowing you to appreciate the extraordinary charm and luxury of modern architecture.



Moving walk

The compact design of the rail pre-assembly technology and mechanical system of the FUJI moving walkway and the handrail drive system has reduced the size of the sidewalk and enabled the building's space to be used effectively.

Human-machine interface



JG-CZ001
Optional

Display optional

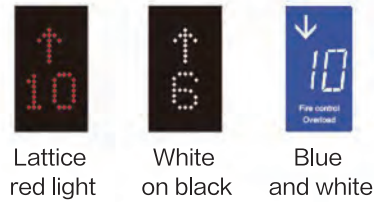

Lattice red light
White on black
Blue and white

None bottom outer calling



JG-108e
Optional

JG-108f
Optional



JG-108h
Optional
Super-thin



JG-108d
Optional



JG-108g
Optional
Super-thin



JG-340
Optional

Have bottom outer calling



JG-340a
Optional



JG-340b
Optional



JG-340c
Optional



JG-006
Optional



JG-006a
Optional



JG-006b
Optional



JG-006c
Optional

Man-Machine interface

JG-108
Optional

Optional display
Optional : Hairline,
Black Titanium gold

Display screen



Blue screen Optional True color Optional Multi-Media Optional

Multimedia display size : 7 inch,10 inch



Due to the limitations of the printing process, the color of the actual processing may be slightly different from the catalog, and the final selection may be based on the actual material and the color sample.

Hoist-way horizontal display



JG-HX01
Optional



JG-HX02
Optional

Arrival gong



JG-DZ01
Optional



JG-DZ02
Optional



JG-131
Optional

Have bottom outer calling



JG-131a
Optional

Ceiling series

Each detail is crafted, Zhenyu is perfect, shows the beauty of modern craftsmanship, merges with architecture, and pours in pursuit of excellence

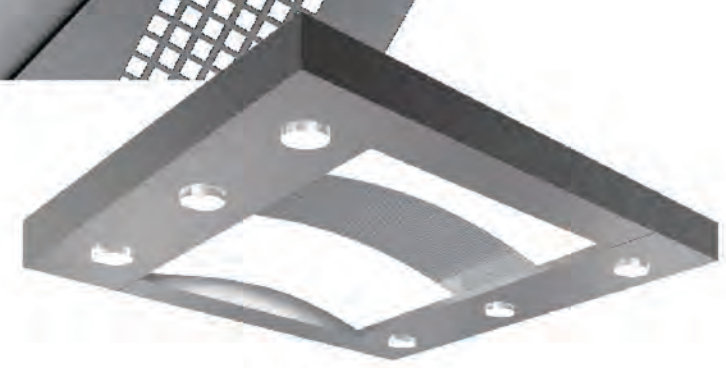

JG-D01

Baked enamel steel frame, circle carve transparent light and vaulted white transparent light board for soft illumination design



JG-D03

Baked enamel steel frame, circle carve transparent light and vaulted white transparent light board for soft illumination design



JG-D04

Middle with image roof, side of stainless steel floor with down lamp for soft illumination design



JG-D05

Multi-layer glisten board and stainless steel mirror curve board with transparent light for soft illumination design

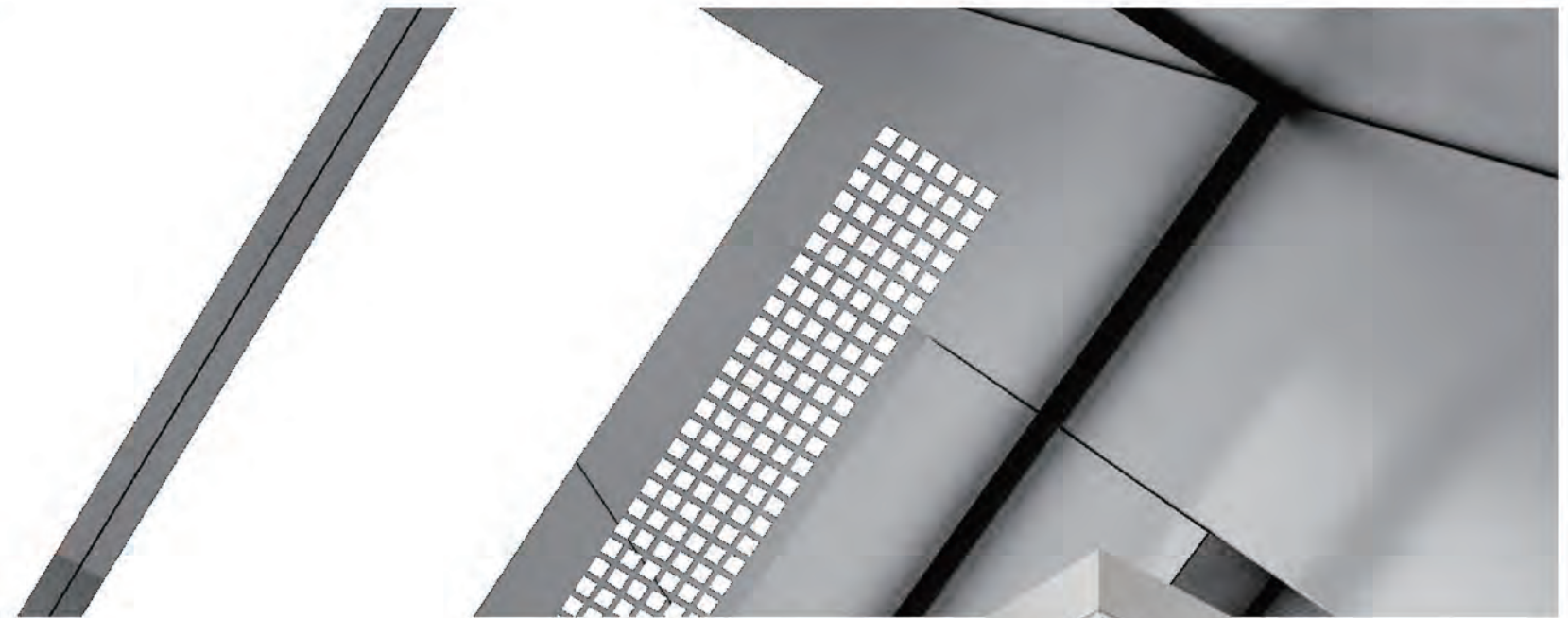

JG-D06

Stainless steel mirror hollow pale with white organic panel, aluminum alloy frame



JG-D07

Integrated ceiling

Mirror stainless steel, acrylic lighting decoration, LED lamps on both sides



JG-D07B

Integrated ceiling

Mirror stainless steel, acrylic lighting decoration



JG-D08

Stainless steel frame with white organic panel



Landing door series



JG-M01

JG-M02

JG-M03

JG-M04



JG-M05

JG-M06

JG-M07

JG-M08

Optional color series



Note : Due to the limitations of the printing process, the color of the actual processing may be slightly different from the catalog, and the final selection may be based on the actual material and the color sample.

Floor series

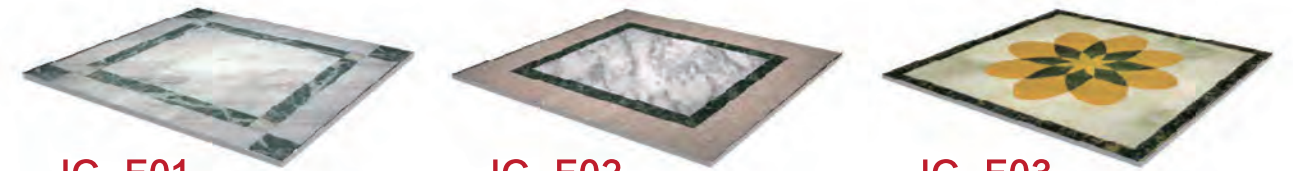

JG-F01

JG-F02

JG-F03



JG-F04

JG-F05

JG-F06



JG-F07

JG-F08

JG-F09

Handrail series



JG-H01

JG-H02

JG-H03

JG-H04

JG-H05

JG-H06

JG-H07

JG-H08

Perfect function

Standard function

VVVF drive	Motor rotating speed can be precisely adjusted to get smooth speed curve in lift start, travel and stop and gain the sound comfort.
VVVF door operator	Motor rotating speed can be precisely adjusted to get the more gentle and sensitive door machine start / stop.
Independent running	The lift can not respond to outer calling, but only respond to the command inside the car through the action switch.
Automatic pass without stop	When the car is crowded with the passengers or the load is close to preset value, the car will automatically pass the calling landing in order to keep maximum travel efficiency.
Automatically adjust door opening time	Door-open time can be automatically adjusted according to the difference between landing calling or car calling.
Reopen with hall call	In the door shutting process, press reopen with hall call button can restart the door.
Express door closing	When the lift stops and opens the door, press door-shut button, the door will be closed immediately.
Car stops and door open	The lift decelerates and levels, the door only opens after the lift comes to a complete stop.
Car arrival gong	Arrival gong in the car top announces that the passengers arrive.
Command register cancel	If you press the wrong floor command button in the car, twice continuous pressing of same button can cancel the registered command.
Photocell protection	In the door open and shut period, infrared light that covers the whole door height is used to probe the door protection device of both the passengers and objects.
Designated stop	If the lift can not open the door in the destination floor out of some reason, the lift will close the door and travel to the next designated floor.
Overload holding stop	When the car is overload, the buzzer rings and stops the lift in the same floor.
Anti-stall timer protection	The lift stops operation due to slippery traction wire rope.
Start protection control	If the lift does not leave door zone within the designated time after it gets started, it will stop the operation.
Inspection operation	When the lift enters into inspection operation, the car travels at inching running.
Fault self-diagnosis	The controller can record 62 latest troubles so as to quickly remove the trouble and restore the lift operation.
Repeated door closing	If the lift can not close the door due to certain obstacle or interference, the lift will reopen or re-shut the door until sundries are eliminated.
Up/down over-run and final limit protection	The device can effectively prevent from the lift's surging to the top or knocking the bottom when it is out of the control. It results in the more safe and reliable lift travel.
Down over-speed protection device	When the lift downs 1.2 times higher than the rated speed, this device will automatically cut off control mains, stop the motor running so as to stop lift down at over-speed. If the lift continues to down at over-speed, and the speed is 1.4 times higher than rated speed, safety tongs act to force the lift stop in order to ensure the safety.
Upward over-speed protection device	When the lift ups 1.2 times higher than rated speed, the device will automatically decelerate or brake the lift.
Micro-touch button for car call and hall call	Novel micro-touch button is used for operation panel command button in the car and landing calling button.
Floor and direction indicator inside car	The car shows the lift floor location and current travel direction.
Floor and direction indicator	The landing shows the lift floor location and current travel direction.
Emergency car lighting	Emergency car lighting automatically activated once power failure.
Inching running	When the lift enters into emergency electric operation, the car travels at low speed inching running.

Optional function

Five way intercom	Communication amid car, car top, lift machine room, well pit and rescue duty room through walkie-talkie.
Bell	In emergency conditions, if bell button above car operation panel is continuously pressed, electric bell rings on top of the car.
Fire emergency return	If you start key switch in main landing or monitor screen, all the callings will be cancelled. The lift directly and immediately drives to the designated rescue landing and automatically opens the door.
Car ventilation, light automatic shut off	If there is no calling or command signal within the stipulated time, the car fan and lighting will be automatically closed in order to save the energy.
Remote shut-off	The lift can be called to main landing (after finishing the service) through the key switch and automatically exists the service.
Leveling when power failure	In normal power failure, the chargeable battery supplies the lift power. The lift drives to the nearest landing.
Anti- nuisance	In the light lift load, when three more commands appear, in order to avoid the unnecessary parking, all the registered callings in the car will be cancelled.
Open the door in advance	When the lift decelerates and enters into door open zone, it automatically opens the door to enhance the travel efficiency.
Direct parking	It completely accords with distance principle with no crawling in the leveling. It greatly enhances the travel efficiency.
Group control function	When three or more same model lift groups are controlled in use, the lift group can automatically choose the most appropriate response. It avoids the repeated lift parking, reduces the passengers' waiting time and increases the travel efficiency.
Duplex control	Two sets of same model lifts can unanimously respond the calling signal through the computer dispatch. In this way, it reduces the passengers' waiting time to the greatest extent and enhances the travel efficiency as well.
On-duty peak service	Within the preset on-duty time, upward transport from the home landing is extremely busy. The lifts are continuously dispatched to the home landing in order to satisfy on-duty peak service.
Off-duty peak service	Within the preset off-duty period, the lifts are continuously dispatched to top floor in order to satisfy off-duty peak service.
Door open time extending	Press special button in the car, the lift door keeps open for certain period of time.
Voice announcer	When the lift normally arrives, voice announcer informs the passengers about the relevant information
Car assistant operation box	It is used in the large loading weight lifts or the lifts with crowded passengers so that more and more passengers can use the car.
Operation box for the handicapped	It is convenient for the wheelchair passengers and those who have vision problems.
Intelligent calling service	The car command or hoist-way calling can be locked or connected through special Intelligent Input.
IC card control function	All (partial) landings can only input car commands through IC Card after the authorization.
Remote monitor	The lift long-distance monitor and control can be fulfilled through modem and telephone. It is convenient for the factories and service units to timely know the travel conditions of every lift and promptly take the corresponding measures.
Remote control	The lift can have independent travel according to the specific requirements through operation monitor screen (optional).
Camera function in the car	The camera is installed in the car to monitor the car conditions.

Small machine room passenger elevator construction sketch

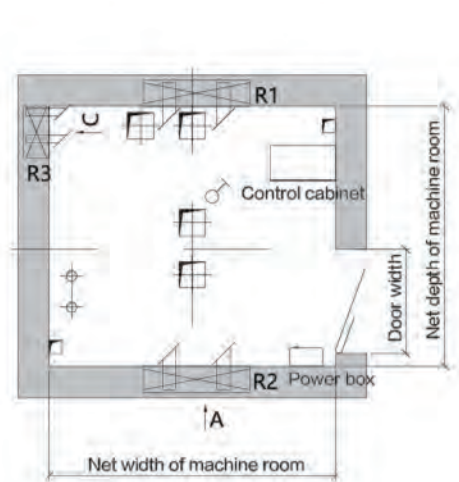

Machine room layout chart

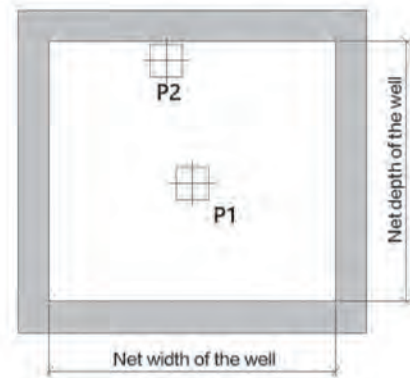
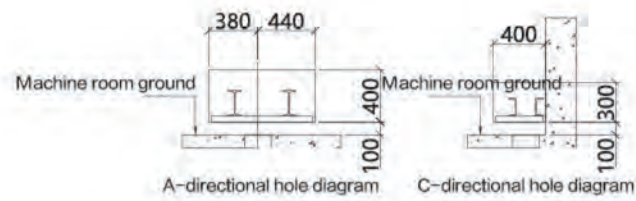

Pit plan

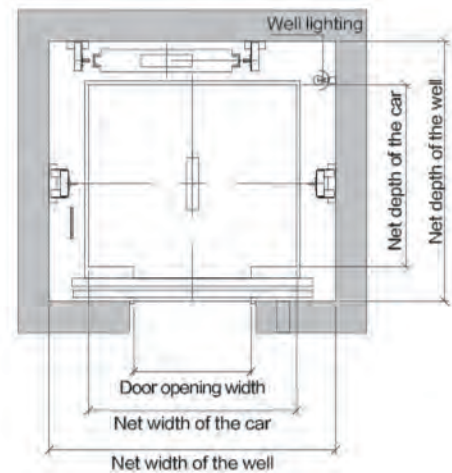

Well plan

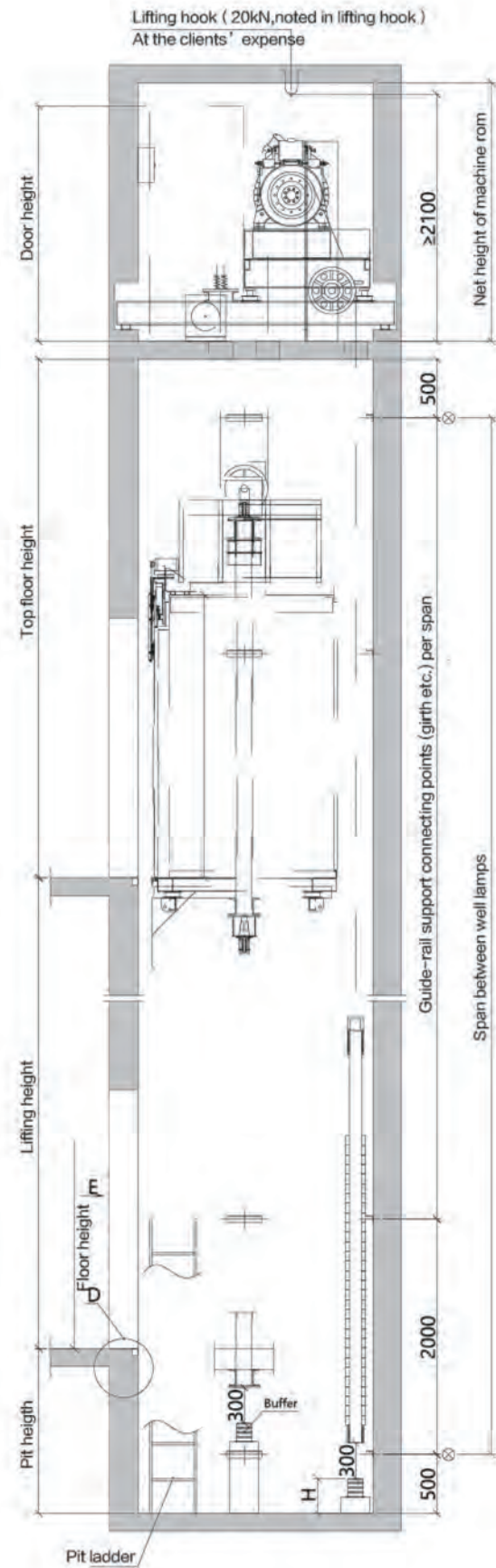

Vertical view of well side

Model	Load KG	Passenger NO.	speed m/s	Car specification CWxCD	Door opening size JJxOPH	Well size HWxHD	Machine room size MRWxMRD	Pit depth Pit	Top floor height OH	Power	Acting force				
											R1	R2	R3	P1	P2
TKJ450/1.0	450	6	1	1100x1100	700x2100	1700x1700	1700x1700	1400	4500	3.2	28800	17200	1900	44000	35000
TKJ450/1.5			1500					4600	4.9						
TKJ630/1.0	630	8	1	1400x1100	800x2100	2000x1700	2000x1700	1400	4500	4.3	35200	21800	4300	58000	45600
TKJ630/1.5			1500					4600	6.4						
TKJ630/1.75			1600					4700	7.5						
TKJ800/1.0	800	10	1	1400x1350	800x2100	2000x2000	2000x2000	1400	4500	5.4	44800	27400	5400	72000	56000
TKJ800/1.5			1500					4600	8.1						
TKJ800/1.75			1600					4700	9.4						
TKJ1000/1.0	1000	13	1	1600x1400	900x2100	2200x2000	2200x2000	1400	4500	6.7	53400	32200	6000	88000	68000
TKJ1000/1.5			1500					4600	10						
TKJ1000/1.75			1600					4700	11.7						
TKJ1150/1.0	1150	15	1	1900x1400	1000x2100	2500x2100	2500x2100	1400	4600	7.8	55600	36300	7800	98000	75000
TKJ1150/1.5			1500					4700	11.7						
TKJ1150/1.75			1600					4800	13.6						
TKJ1250/1.0	1250	16	1	1900x1500	1100x2100	2500x2200	2500x2200	1400	4600	8.5	60400	39400	8500	106000	81000
TKJ1250/1.5			1500					4700	12.7						
TKJ1250/1.75			1600					4800	14.9						
TKJ1350/1.0	1350	18	1	1900x1600	1100x2100	2500x2300	2500x2300	1400	4600	9.2	67200	43400	8700	114000	87000
TKJ1350/1.5			1500					4700	13.8						
TKJ1350/1.75			1600					4800	16.1						
TKJ1600/1.0	1600	21	1	2000x1750	1200x2100	2600x2450	2600x2450	1400	4600	11	73600	47600	9600	128000	96000
TKJ1600/1.5			1500					4700	16.6						
TKJ1600/1.75			1600					4800	19.4						

(The data is for design reference only. Regarding detailed parameters, please take technical drawing as criterion.)
 Note: If specification exceeds above range, please contact FUJI Elevator Company.

Machine room-less passenger elevator construction sketch(economical)

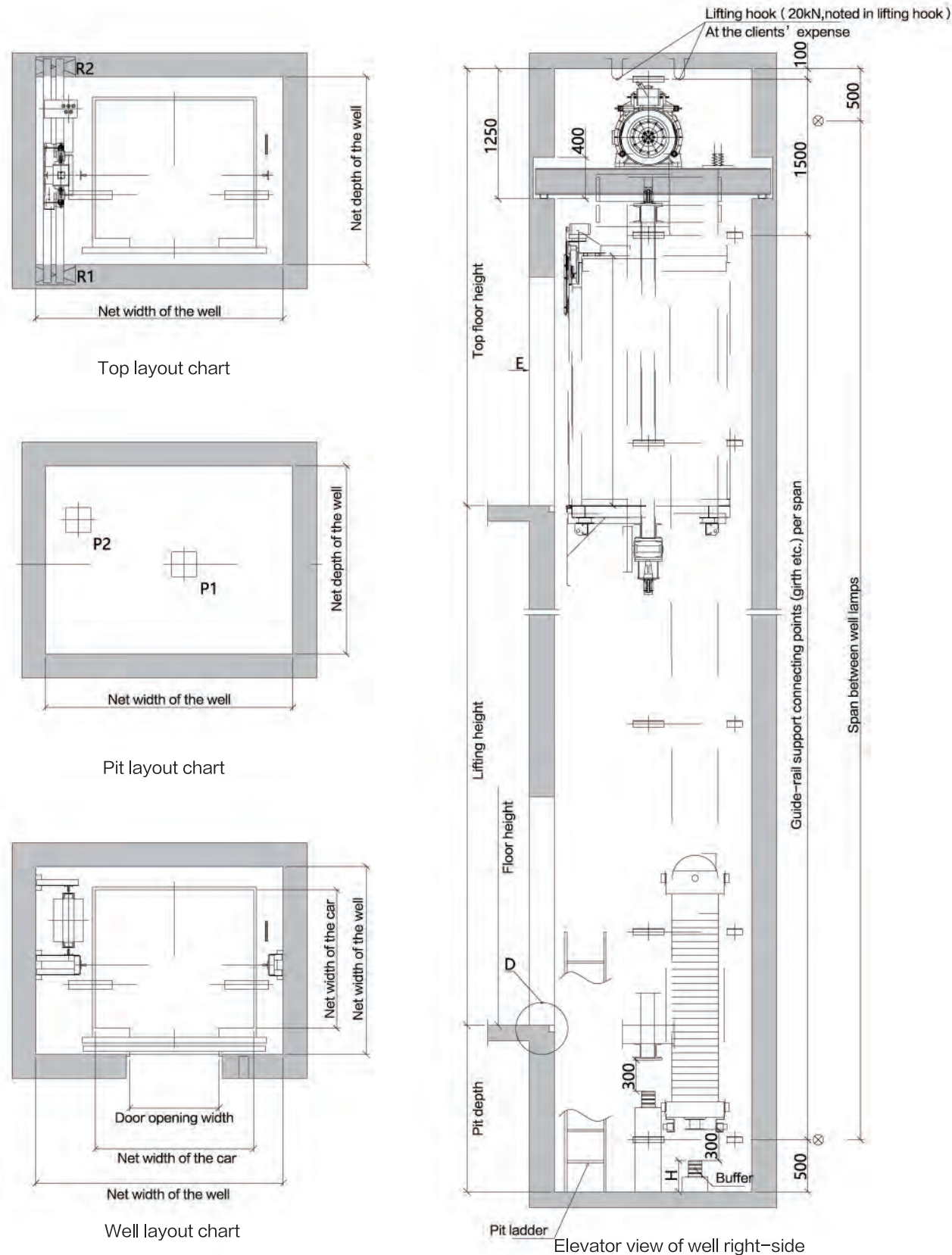

Model	Load KG	Passenger NO.	speed m/s	Car specification CWxCD	Door opening size JJxOPH	Well size HWxHD	Pit depth Pit	Top floor height OH	Power	Acting force			
										R1	R2	P1	P2
TKJW450/1.0	450	6	1	1100x1100	700x2100	2000x1700	1600	4300	3.2	16500	21000	44000	35000
TKJW450/1.5			1700				4400	4.9					
TKJW630/1.0	630	8	1	1400x1100	800x2100	2300x1700	1600	4300	4.3	19800	26400	58000	45600
TKJW630/1.5			1700				4400	6.4					
TKJW630/1.75			1700				4400	7.5					
TKJW800/1.0	800	10	1	1400x1350	800x2100	2300x2000	1600	4300	5.4	25700	27100	72800	56000
TKJW800/1.5			1700				4400	8.1					
TKJW800/1.75			1700				4400	9.4					
TKJW1000/1.0	1000	13	1	1600x1400	900x2100	2500x2000	1600	4300	6.7	27400	39600	88000	68000
TKJW1000/1.5			1700				4400	10					
TKJW1000/1.75			1700				4400	11.7					
TKJW1150/1.0	1150	15	1	1900x1400	1000x2100	2800x2000	1600	4300	7.8	30400	43600	92000	75000
TKJW1150/1.5			1700				4400	11.7					
TKJW1150/1.75			1700				4400	13.6					
TKJW1250/1.0	1250	16	1	1900x1500	1100x2100	2900x2000	1600	4300	8.5	32200	46800	106000	81000
TKJW1250/1.5			1700				4400	12.7					
TKJW1250/1.75			1700				4400	14.9					
TKJW1350/1.0	1350	18	1	1900x1600	1100x2100	2900x2400	1600	4400	9.2	37600	46400	114000	87000
TKJW1350/1.5			1700				4500	13.8					
TKJW1350/1.75			1700				4500	16.1					
TKJW1600/1.0	1600	21	1	2000x1750	1200x2100	3000x2400	1600	4400	11	39600	56500	128000	96000
TKJW1600/1.5			1700				4500	16.6					
TKJW1600/1.75			1700				4500	19.4					

(The data is for design reference only. Regarding detailed parameters, please take technical drawing as criterion.)
 Note: If specification exceeds above range, please contact FUJII Elevator Company.

Machine room-less passenger elevator construction sketch(compact)

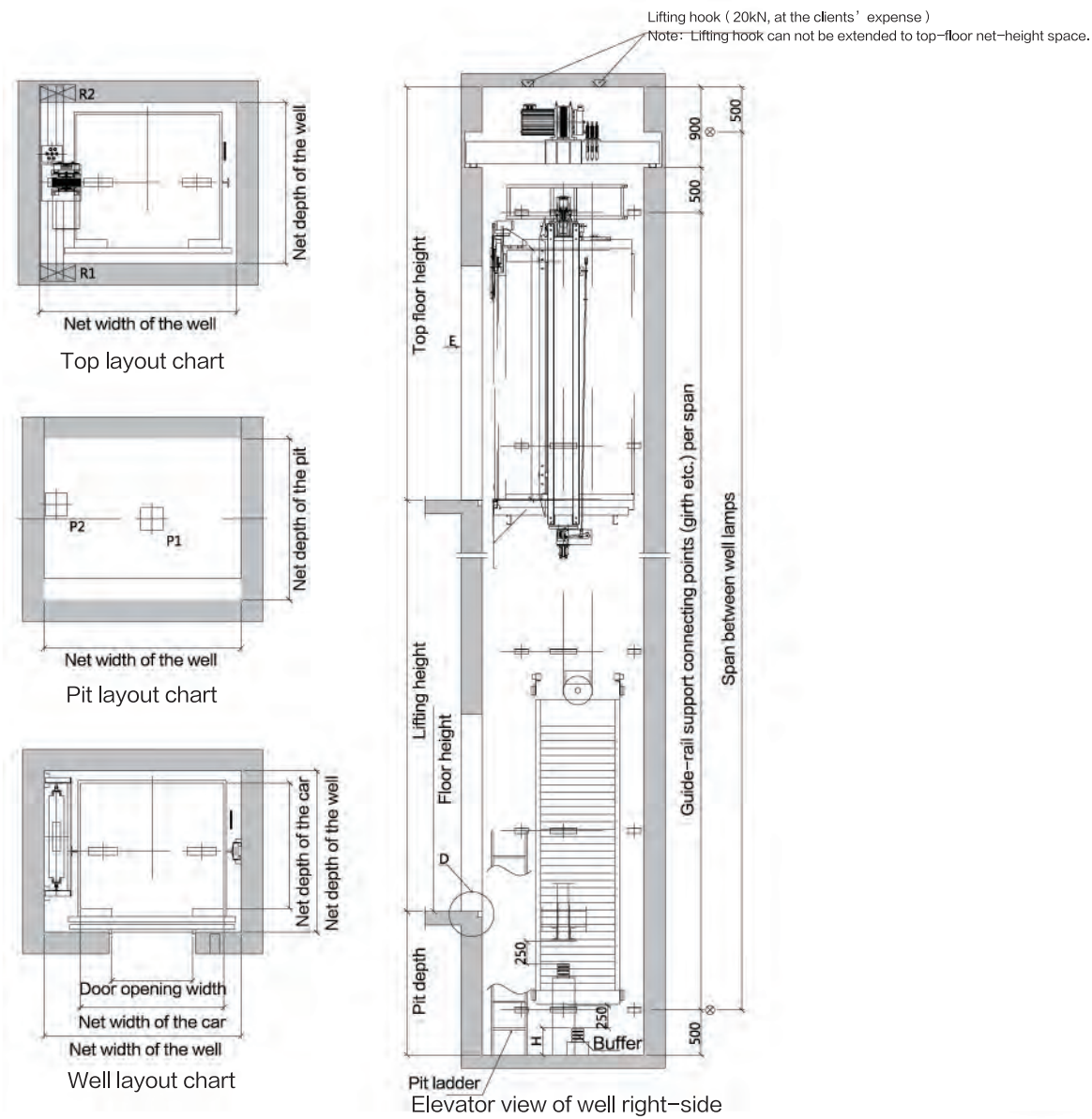

High speed elevator construction sketch

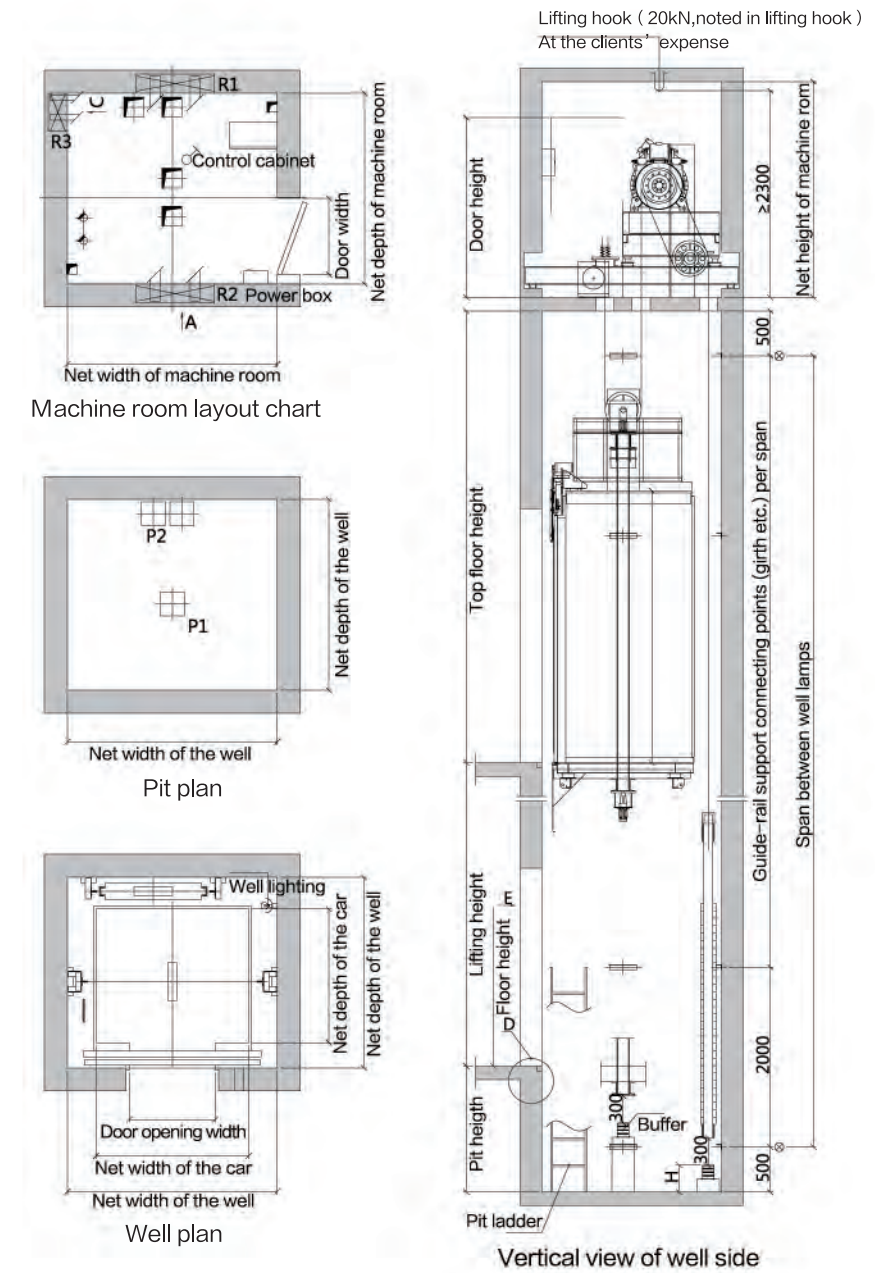

Model	Load KG	Passenger NO.	speed m/s	Car specification CWxCD	Door opening size JJxOPH	Well size HWxHD	Pit depth Pit	Top floor height OH	Power	Acting force			
										R1	R2	P1	P2
TKJW630/1.0	630	8	1	1200x1350	700x2100	1850x1750	1500	4600	4.0	19800	26400	58000	45600
TKJW630/1.5			1600				4700	6.3					
TKJW630/1.75			1700				4800	7.3					
TKJW800/1.0	800	10	1	1400x1350	800x2100	2050x1750	1500	4600	5.4	25700	27100	72800	56000
TKJW800/1.5			1600				4700	8.1					
TKJW800/1.75			1700				4800	9.4					
TKJW1000/1.0	1000	13	1	1600x1400	900x2100	2250x1800	1500	4600	6.7	27400	39600	88000	68000
TKJW1000/1.5			1600				4700	10.1					
TKJW1000/1.75			1700				4800	11.8					

(The data is for design reference only. Regarding detailed parameters, please take technical drawing as criterion.)
Note: If specification exceeds above range, please contact FUJI Elevator Company.

Model	Load KG	Pas-senger NO.	speed m/s	Car specification CWxCD	Door opening size JJxOPH	Well size HWxHD	Machine room size MRWxMRD	Pit depth Pit	Top floor height OH	Power	Acting force				
											R1	R2	R3	P1	P2
TKJ630/2.0	630	8	2	1400x1100	800x2100	2000x1800	2000x1800	1700	5000	8.2	44800	27400	5400	72000	56000
TKJ800/2.0	800	10	2	1400x1350	800x2100	2000x2050	2000x2050	1700	5000	10.9	44800	27400	5400	72000	56000
TKJ800/2.5			1900					5200	13.5						
TKJ800/3.0			2100x2050					2100x2050	3200	5700					
TKJ1000/2.0	1000	13	2	1600x1400	900x2100	2200x2100	2200x2100	1700	5000	13.3	53400	32200	6000	88000	68000
TKJ1000/2.5			1900					5200	16.8						
TKJ1000/3.0			3200					5700	20.3						
TKJ1000/4.0			2300x2100					2300x2100	4000	6200					

(The data is for design reference only. Regarding detailed parameters, please take technical drawing as criterion.)
Note: If specification exceeds above range, please contact FUJI Elevator Company.

Hospital elevator construction sketch

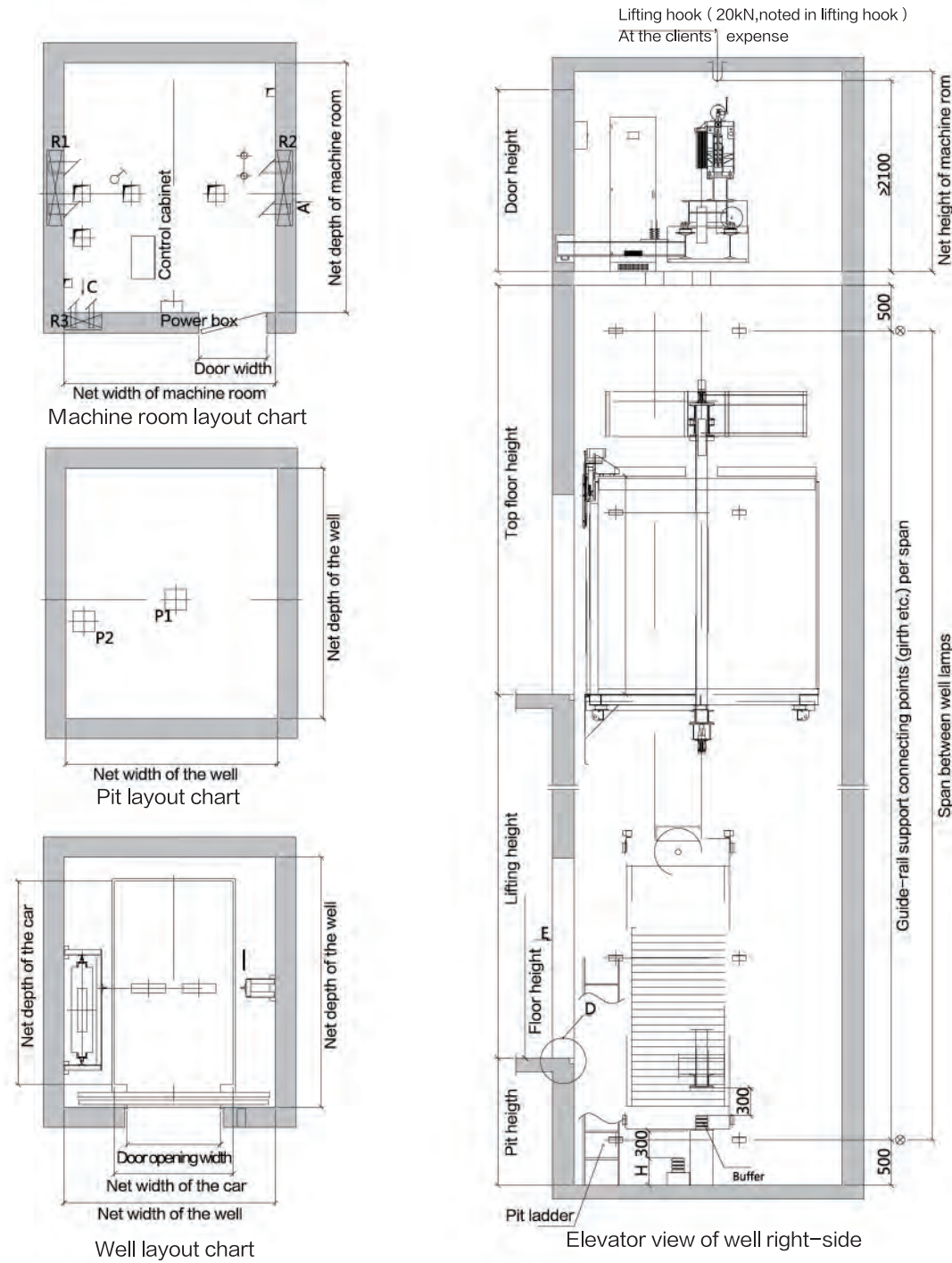

Model	Load KG	Passenger NO.	speed m/s	Car specification CWxCD	Door opening size JJxOPH	Well size HWxHD	Machine room size MRWxMRD	Pit depth Pit	Top floor height OH	Power	Acting force				
											R1	R2	R3	P1	P2
TBJ1600/1.0	1600	21	1	1400x2400	1100x2100	2500x2950	2500x2950	1400	4600	11	73600	47600	9600	128000	96000
TBJ1600/1.5			1500					4700	16.6						
TBJ1600/1.75			1600					4800	19.4						

(The data is for design reference only. Regarding detailed parameters, please take technical drawing as criterion.)
 Note: If specification exceeds above range, please contact FUJII Elevator Company.

Machine room-less observation elevator construction sketch(square)

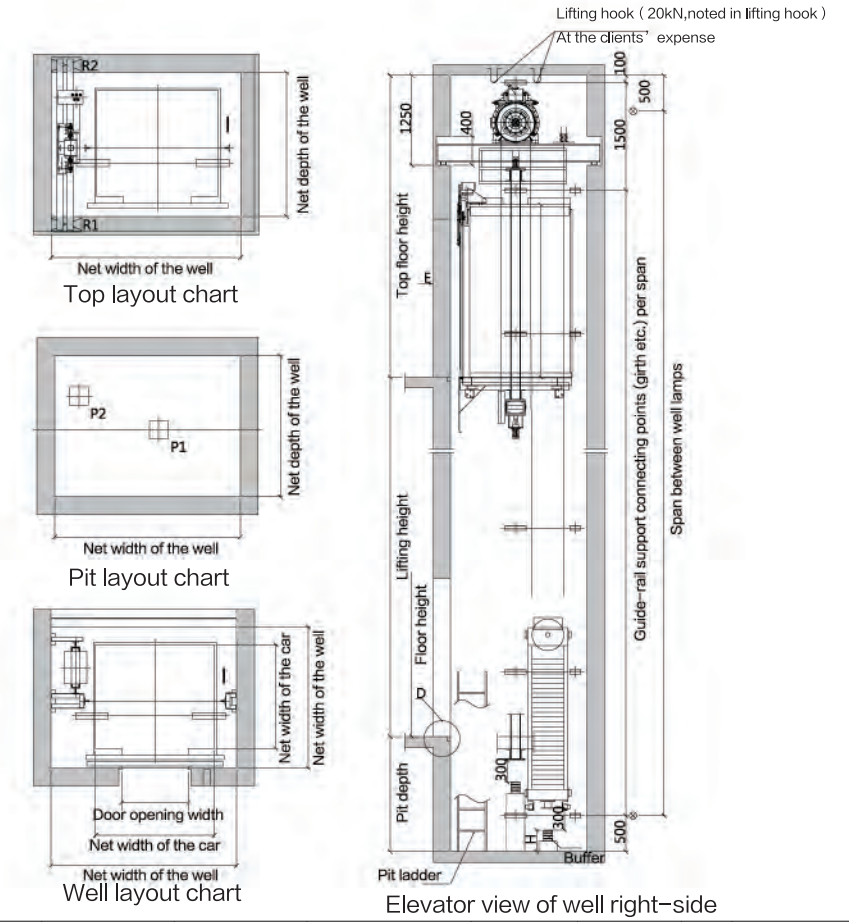

Model	Load KG	Passenger NO.	speed m/s	Car specification CWxCD	Door opening size JJxOPH	Well size HWxHDmin-HDmax	Pit depth Pit	Top floor height OH	Power	Acting force			
										R1	R2	P1	P2
TGJW450/1.0	450	6	1	1100x1100	700x2100	2000x1700	1600	4600	3.2	16500	21000	44000	35000
TGJW450/1.5			1700				4700	4.9					
TGJW630/1.0	630	8	1	1200x1300	800x2100	2100x1800	1600	4600	4.3	19800	26400	58000	45600
TGJW630/1.5			1700				4700	6.4					
TGJW630/1.75			1700				4700	7.5					
TGJW800/1.0	800	10	1	1400x1350	800x2100	2300x2000	1600	4600	5.4	25700	27100	72800	56000
TGJW800/1.5			1700				4700	8.1					
TGJW800/1.75			1700				4700	9.4					
TGJW1000/1.0	1000	13	1	1600x1400	900x2100	2500x2000	1600	4600	6.7	27400	39600	88000	68000
TGJW1000/1.5			1700				4700	10					
TGJW1000/1.75			1700				4700	11.7					
TGJW1150/1.0	1150	15	1	1900x1400	1000x2100	2800x2000	1600	4600	7.8	30400	43600	92000	75000
TGJW1150/1.5			1700				4700	11.7					
TGJW1150/1.75			1700				4700	13.6					
TGJW1250/1.0	1250	16	1	1900x1500	1100x2100	2900x2000	1600	4600	8.5	32200	46800	106000	81000
TGJW1250/1.5			1700				4700	12.7					
TGJW1250/1.75			1700				4700	14.9					
TGJW1350/1.0	1350	18	1	1900x1600	1100x2100	2900x2400	1600	4600	9.2	37600	46400	114000	87000
TGJW1350/1.5			1700				4700	13.8					
TGJW1350/1.75			1700				4700	16.1					
TGJW1600/1.0	1600	21	1	2000x1750	1200x2100	3000x2400	1600	4600	11	39600	56500	128000	96000
TGJW1600/1.5			1700				4700	16.6					
TGJW1600/1.75			1700				4700	19.4					

(The data is for design reference only. Regarding detailed parameters, please take technical drawing as criterion.)
 Note: If specification exceeds above range, please contact FUJII Elevator Company.

Machine room-less observation elevator construction sketch(round/diamond)

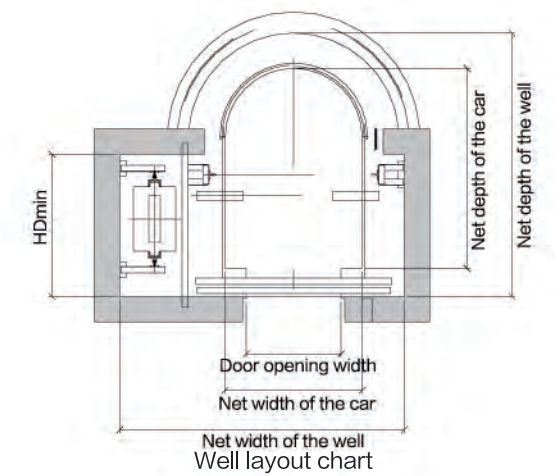
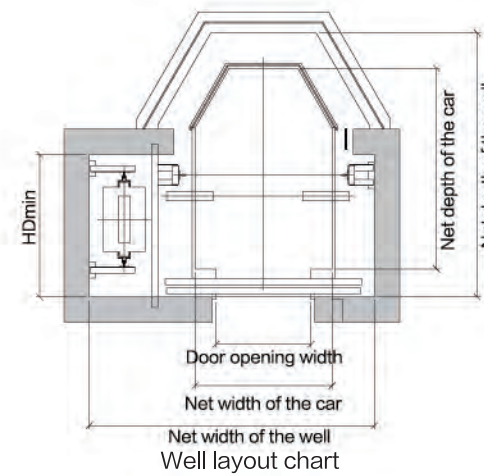
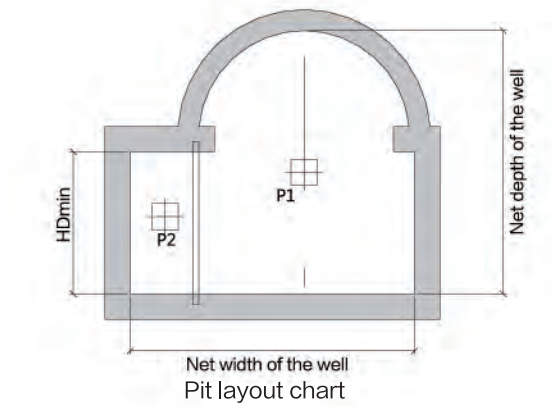
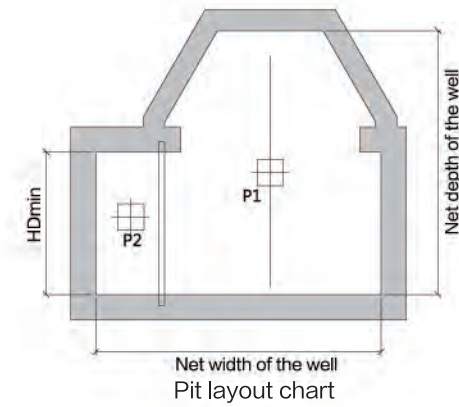
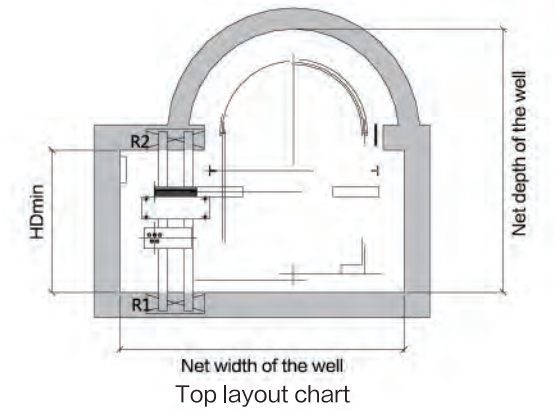
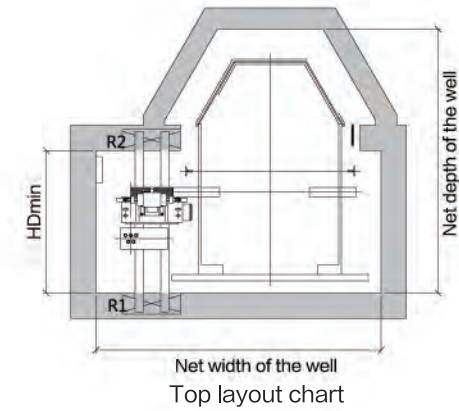
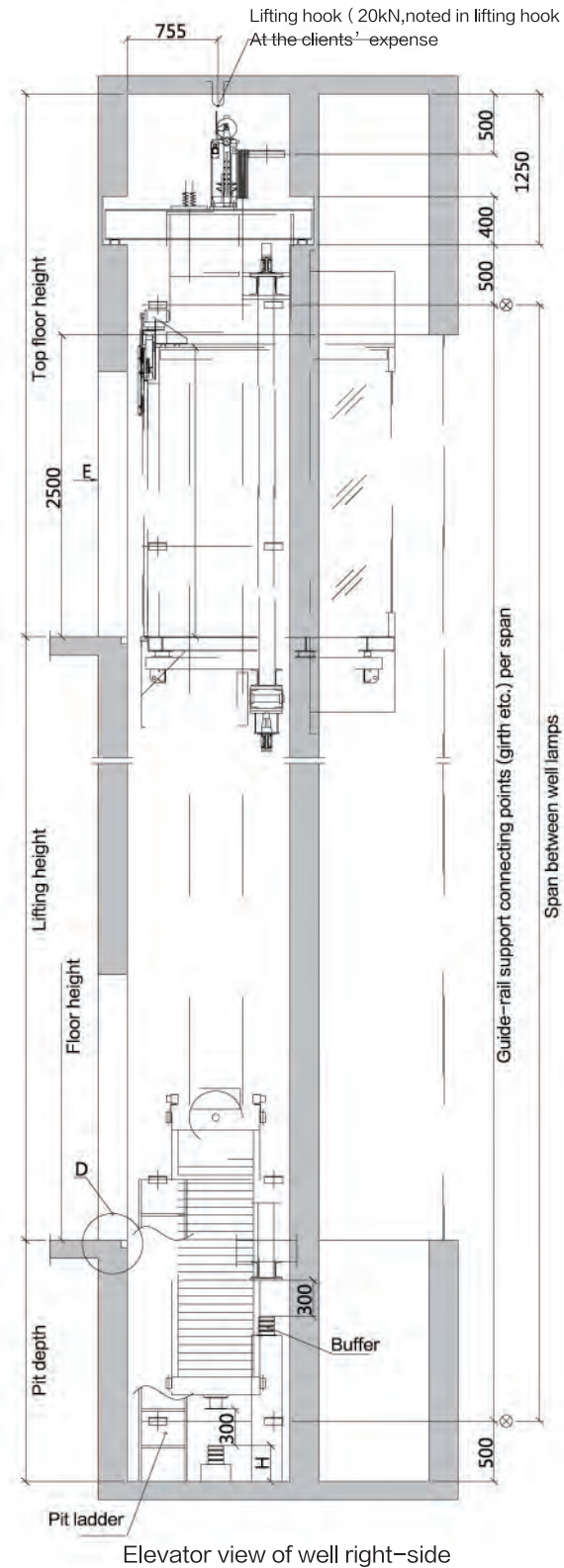
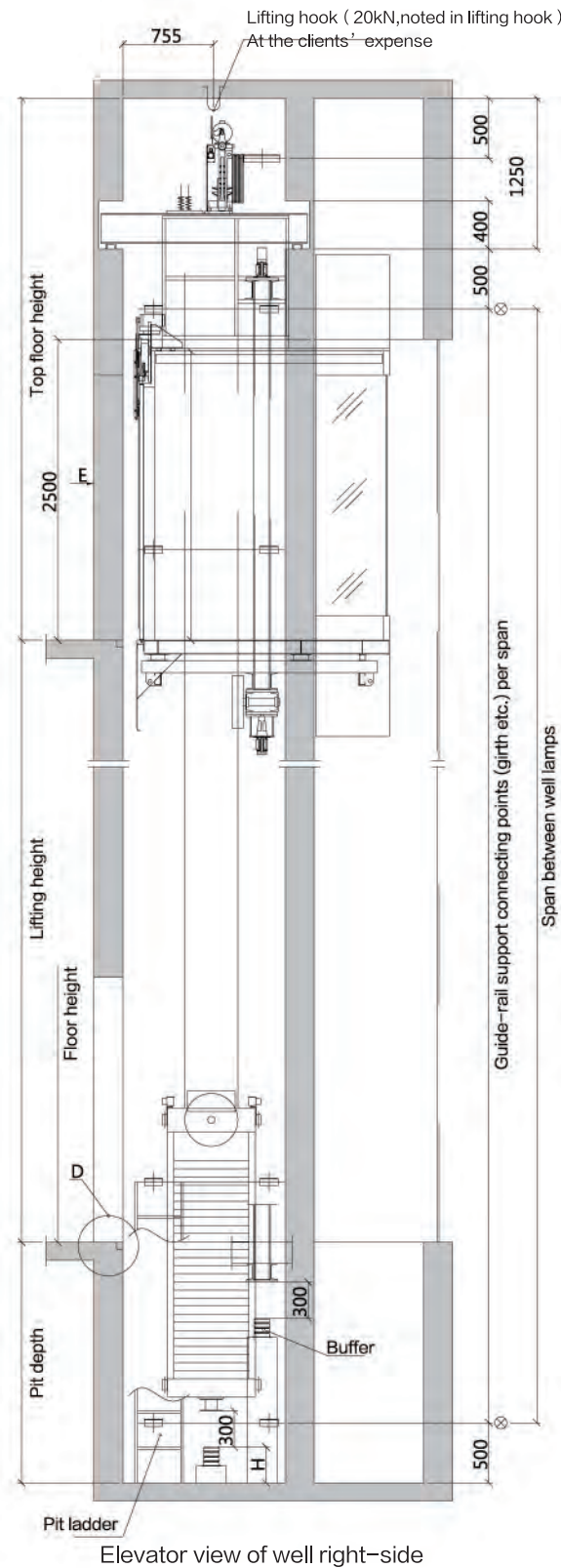

Model	Load KG	Passenger NO	speed m/s	Car specification CWxCD	Door opening size JjxOPH	Well size HWxHDmin-HDmax	Pit depth Pit	Top floor height OH	Power	Acting force			
										R1	R2	P1	P2
TG/W450/1.0	450	6	1	1000x1400	700x2100	2400x1050-2000	1800	4600	3.2	17600	22400	52000	41000
TG/W450/1.5			1900				4700	4.9					
TG/W630/1.0	630	8	1	1100x1600	800x2100	2500x1200-2200	1800	4600	4.3	21200	28800	65000	52000
TG/W630/1.5			1900				4700	6.4					
TG/W630/1.75			1900				4700	7.5					
TG/W800/1.0	800	10	1	1200x1800	800x2100	2600x1300-2400	1800	4600	5.4	25200	35200	80000	64000
TG/W800/1.5			1900				4700	8.1					
TG/W800/1.75			1900				4700	9.4					
TG/W1000/1.0	1000	13	1	1300x1900	900x2100	2700x1350-2500	1800	4600	6.7	29200	42800	96000	76000
TG/W1000/1.5			1900				4700	10					
TG/W1000/1.75			1900				4700	11.7					
TG/W1600/1.0	1600	21	1	1700x2200	1100x2100	3100x1500-2800	1800	4600	11	36600	63400	136000	104000
TG/W1600/1.5			1900				4700	16.6					
TG/W1600/1.75			1900				4800	19.4					

(The data is for design reference only. Regarding detailed parameters, please take technical drawing as criterion.)
 Note: If specification exceeds above range, please contact FUJII Elevator Company.

Villa elevator construction sketch

Lifting hook load-bearing 1500kg (be paid by user)
 Note: Lifting hook can not be extended to top-floor net-height space.

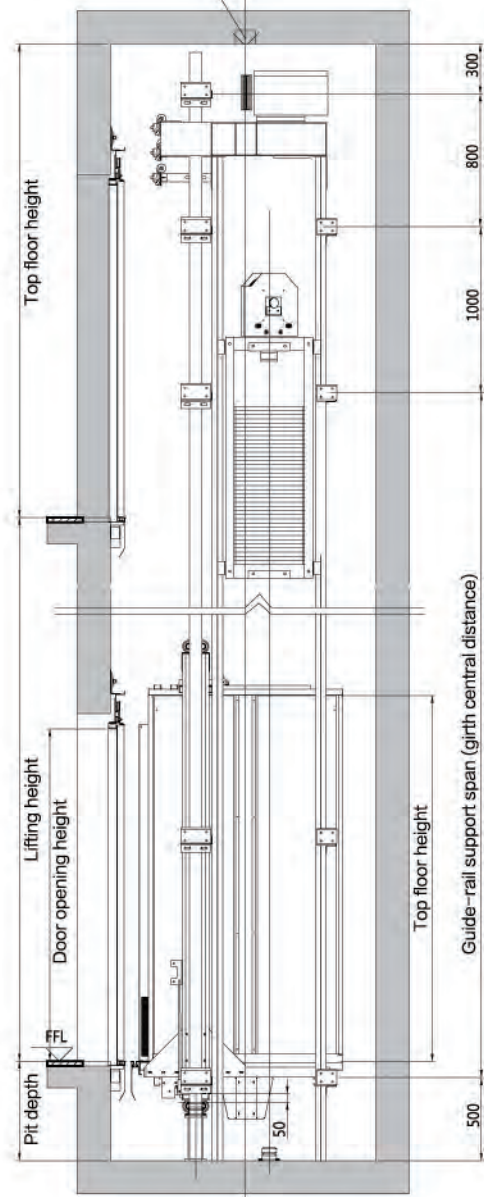

Vertical view of well side

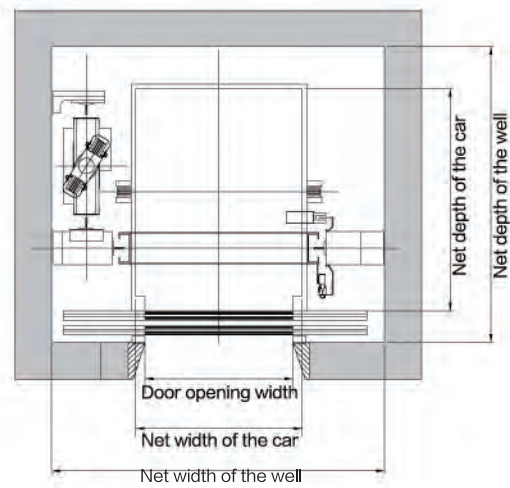

Well layout chart

Model	Load KG	Passenger NO.	speed m/s	Car specification CWxCD	Door opening size JJxOPH	Well size HWxHD	Pit depth Pit	Top floor height OH	Power	Door opening mode
TJJ320/0.4	320	4	0.4	900×1150	800×2000	1800×1500	500	3100	0.9	中分 Center opening
TJJ400/0.4	400	5		900×1200		1800×1600			1.1	
TJJ320/0.4	320	4		900×1150		1600×1500			0.9	旁开 Side opening
TJJ400/0.4	400	5		900×1200		1600×1600			1.1	

(The data is for design reference only. Regarding detailed parameters, please take technical drawing as criterion.)
 Note: If specification exceeds above range, please contact FUJI Elevator Company.

Freight elevator construction sketch

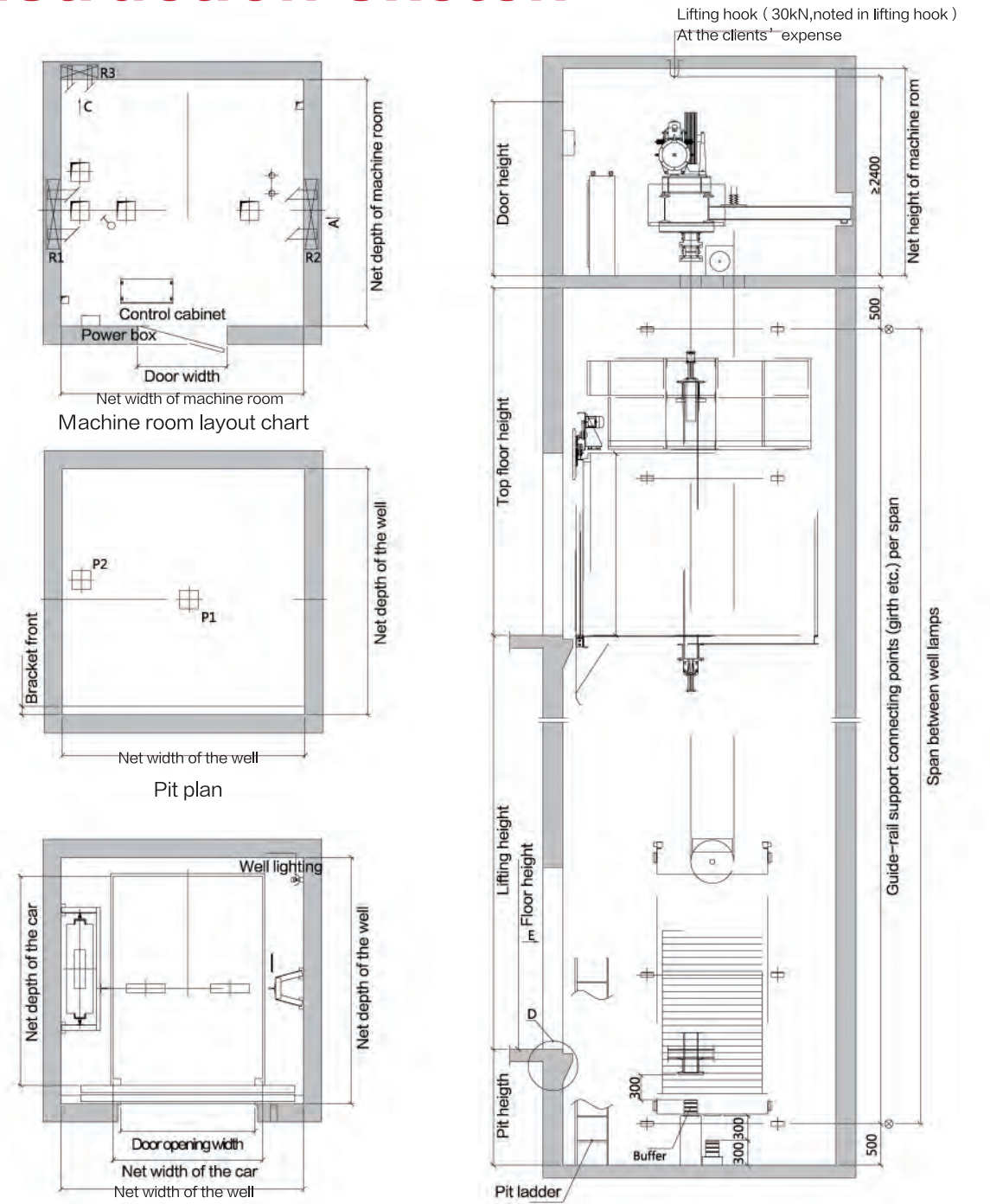

Well layout chart

Elevator view of well right-side

Model	Load KG	speed m/s	Car specification CWxCD	Door opening size JJxOPH	Well size HWxHD	Machine room size MRWxMRD	Pit depth Pit	Top floor height OH	Power	Acting force				
										R1	R2	R3	P1	P2
THJ1000/0.5	1000	0.5	1400×1700	1200×2100	2200×2200	2500×2500	1500	4200	7.5	54600	47800	7400	88000	68000
THJ1600/0.5	1600	0.5	1500×2300	1400×2100	2500×2800	2500×2800	1500	4200	11	67600	58200	7400	124000	92000
THJ2000/0.5	2000	0.5	1800×2300	1500×2100	2800×2800	2800×2800	1500	4200	11	85600	55200	8400	144000	104000
THJ3000/0.5	3000	0.5	2000×2800	1800×2100	3450×3500	3250×3300	1500	4200	15	144800	75200	12000	224000	164000
THJ4000/0.5	4000	0.5	2200×3300	2200×2300	3700×3800	3700×3800	1500	5000	18.5	190000	105200	16400	148000	108000
THJ5000/0.5	5000	0.5	2400×3600	2200×2300	3800×4100	3800×4100	1500	5000	22	213800	117200	18200	172000	122000

(The data is for design reference only. Regarding detailed parameters, please take technical drawing as criterion.)
 Note: If specification exceeds above range, please contact FUJI Elevator Company.

Machine room-less freight elevator construction sketch

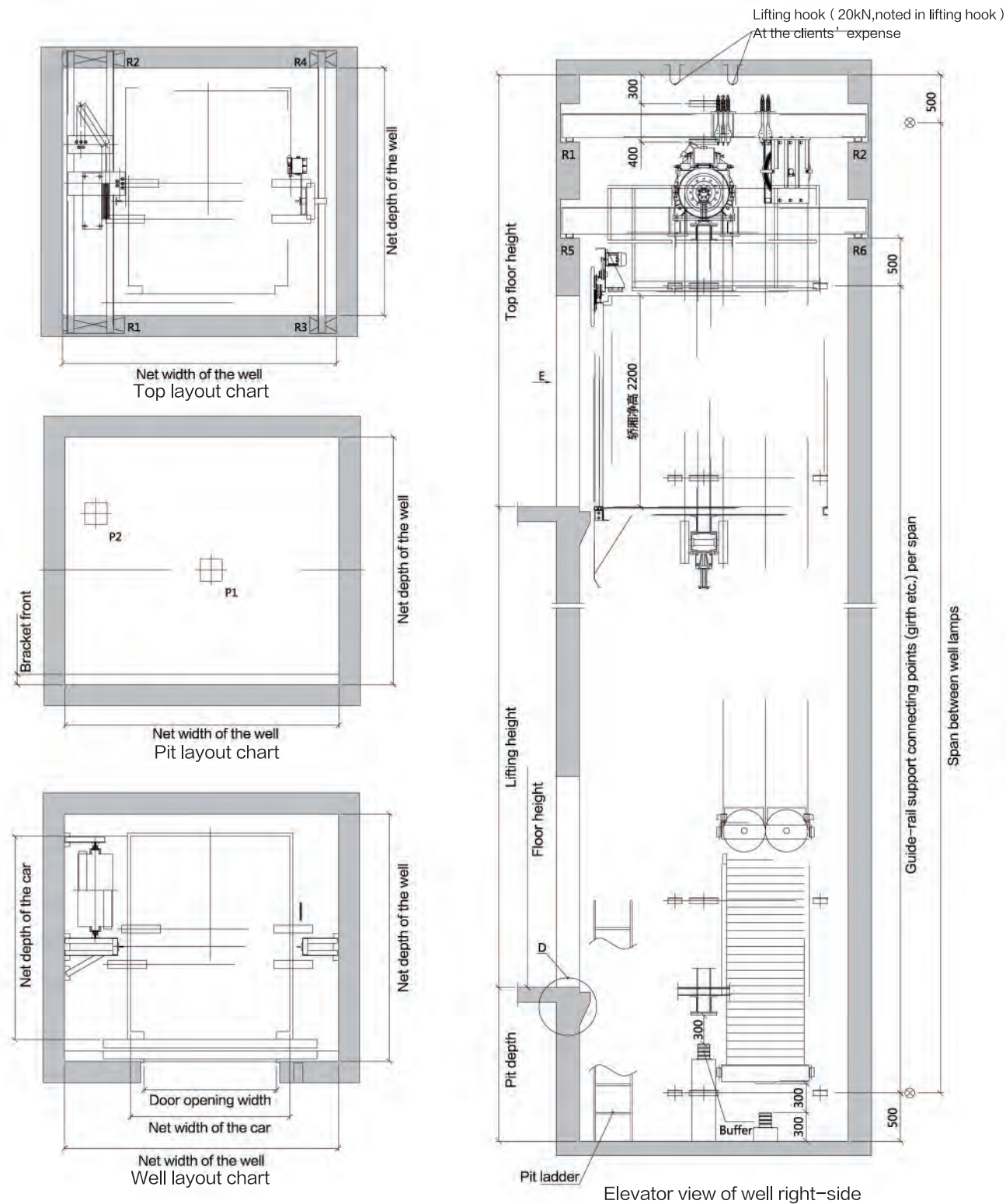

Model	Load KG	speed m/s	Car specification CWxCD	Door opening size JJxOPH	Well size HWxHD	Pit depth Pit	Top floor height OH	Power	Acting force							
									R1	R2	R3	R4	R5	R6	P1	P2
THJW1600/0.5	1600	0.5	1800x1900	1500x2100	3100x2400	1600	4500	5.5	40400	73600	29000	29000	22600	19400	124000	92000
THJW2000/0.5	2000	0.5	1800x2300	1500x2100	3100x2800	1600	4500	6.7	40400	73600	29000	29000	22600	19400	144000	104000
THJW3000/0.5	3000	0.5	2000x2800	1800x2100	3450x3500	1600	4500	10	60600	110400	43500	43500	33900	29100	224000	164000

(The data is for design reference only. Regarding detailed parameters, please take technical drawing as criterion.)
Note: If specification exceeds above range, please contact FUJII Elevator Company.

30°escalator construction sketch

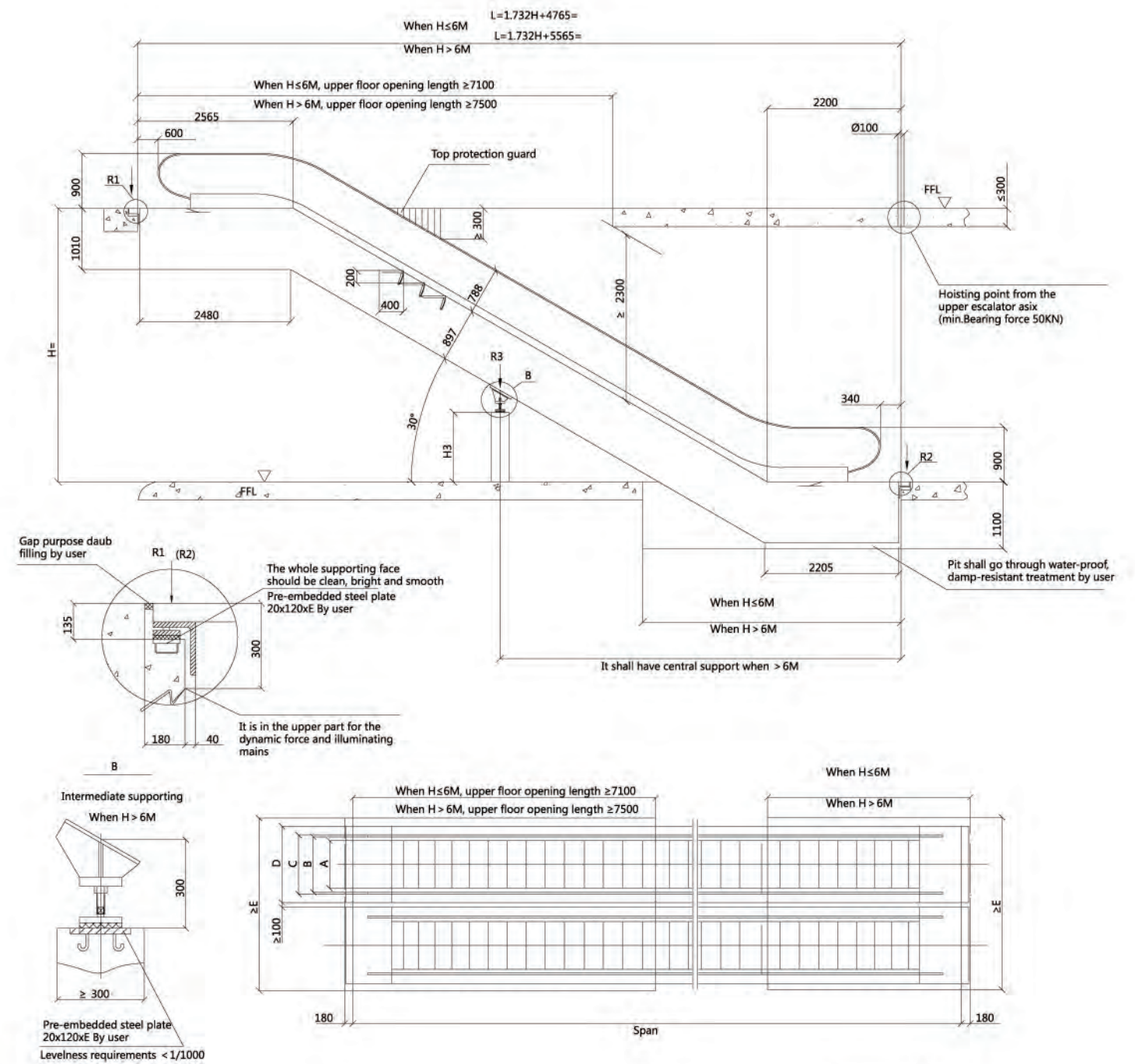

Model	Travelling height(mm)	Net weight (KN)	supporting		Motor power KW	Transport size	
			R1 KN	R2 KN		h	l
VF800/0.5-30° (4800/h)	3000	118	104	94	5.5	2750	10900
	3500	126	112	100		2780	11890
	4000	134	120	108		2810	12880
	4500	142	128	114		2830	13870
	5000	148	136	120		2840	14860
	5500	164	148	132		2860	15860
VF1000/0.5-30° (6000/h)	3000	126	118	106	8	2750	10900
	3500	134	128	114		2780	11890
	4000	142	136	122		2810	12880
	4500	150	146	130		2830	13870
	5000	166	158	142		2840	14860
	5500	174	168	150		2860	15860
6000	184	176	158	2870	16850		

1000	1000	1228	1238	1600	3400
800	800	1028	1038	1400	3000
step width		A	B	C	D
Intermediate supporting $(L/2-2600) \times \tan 30^\circ - (897/\cos 30^\circ + 300)$					

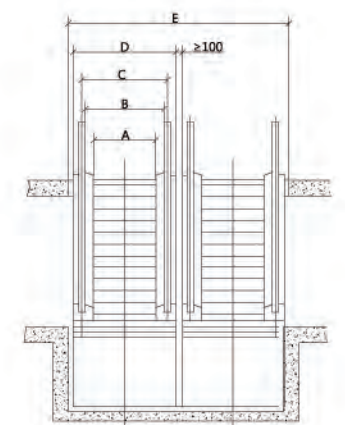

All-round after-sale service



It shows repair and maintenance value produces the considerate service

FUJI Elevator, with its first-class technology, rich management experience and excellent service, enjoys scientific maintenance and strict quality control of its products. We have won wide praise from customers at home and abroad for its stable quality and super high cost performance. Our service outlets have advanced logistics systems all over the country, which can fully guarantee customers' demand for delivery at any time and provide high-quality clothing. Business, early-sub-service, more care.



Professional teams



Prompt & convenient services



Service hot-line



Professional repair & maintenance



Modular installation

Factory modular production, saving installation labor and time costs.
Minimal installation difficulty, minimal assembly errors.



Export directly to the site

Shipping and customs clearance agents in hundreds of countries, tell us where your elevator needs to be installed, provide one-stop service.



7*24-hour safeguard

FUJI elevator adopts a housekeeper service standard to ensure that customers can conduct after-sales consultation within 24 hours at any time, and professional customer service personnel will help customers solve problems for the first time.